

# VS6M

## Solenoid Operated Directional Valve

SUBPLATE MOUNTING  
ISO 4401-03

P max **5000 PSI 350 bar**  
Q max **26 GPM 100 l/min**

### ► DESCRIPTION:

The VS6M series valves are ideal for application in washdown and outdoor mobile environments, and are supplied with a zinc-nickel surface treatment suitable to ensure a salt spray resistance up to 600h (test operated according to UNI EN ISO 9227 standards and test evaluation operated according to UNI EN ISO 10289 standards).

The valve body is made with high strength iron castings with internal passages designed to minimize pressure drop.

The valve can be supplied for valve functions requiring 2 or 3 positions, as well as 3 way or 4 way flow functions.

#### Key Features:

- Coil connections include DIN 43650 and DEUTSCH DT04-2P
- Flows to 26 GPM and multiple spool options
- With 5000 PSI rated work ports and the tank port is rated to 3000 PSI

### ► PERFORMANCE:

(Obtained with mineral oil with viscosity of 36 cSt at 50°C and electronic control card)

Max operating pressure: P - A - B ports T port DC T port AC	PSI (bar)	5000 (350) 3000 (210) DC 2300 (160) AC
Maximum flowrate	GPM (l/min)	26 (100)
Pressure drops $\Delta p-Q$	see page 4	
Operating limits	see page 5 - 6	
Electrical features	see page 10 - 11	
Electrical connections	see page 9	
Ambient temperature range	°F (°C)	-4 / 140 (-20 / +50)
Fluid temperature range	°F (°C)	-4 / 176 (-20 / +80)
Fluid viscosity range	cSt	10 - 400
Fluid contamination degree	according to ISO 4406:1999 class 20/18/15	
Recommended viscosity	cSt	25
Mass: single solenoid valve double solenoid valve	lbs (kg)	3.1 (1,5) 4.4 (2)

VS6M-1A



VS6M-3A

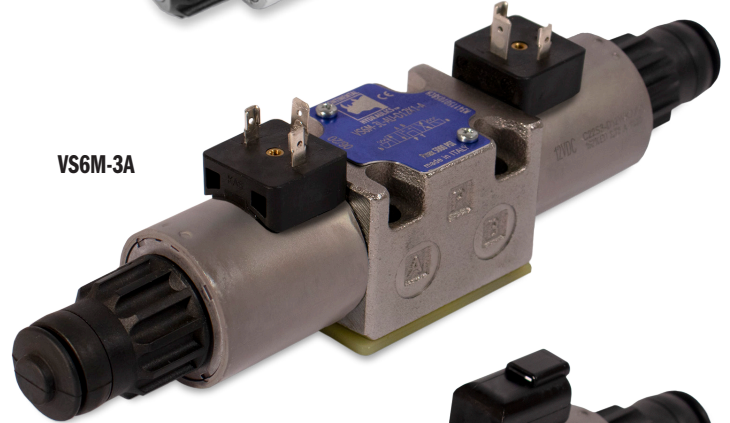

VS6M-WK7

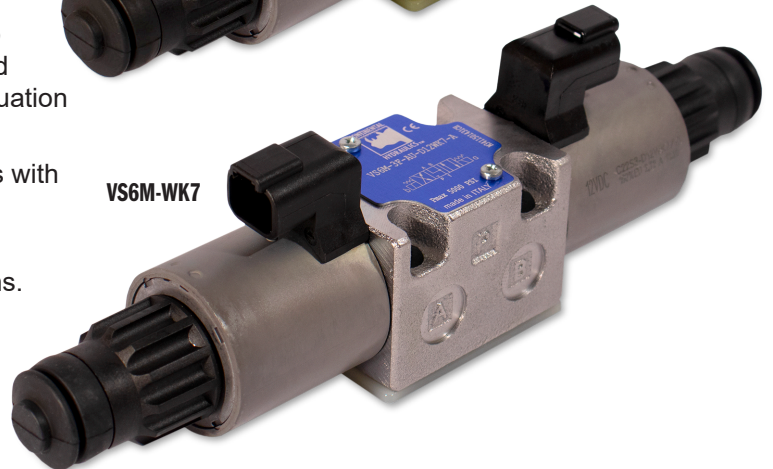

### ► IDENTIFICATION CODE:

**VS6M** -   -    -  -  \_\_\_\_\_ DESIGN LETTER

**BASIC VALVE FUNCTIONS  
/ SPOOL CODES**  
see page 3

SEAL TYPE	
CODE	DESCRIPTION
A	BUNA
G	VITON

MECHANICAL (SELECT 1)	
CODE	DESCRIPTION
OMIT	No options
R	Single Solenoid - B port end
H	Lever Override (DC only)
LL	Long Lever Override (DC Only)

*(See pages 10 and 11 for more details)*

OVERRIDE OPTIONS (SELECT 1)	
CODE	DESCRIPTION
OMIT	No options
U	Manual Override Boot
CP	Push Knob (DC only)
CK1	Turn Knob (DC only)
CPK	Mechanical Detent (DC only)
CK2	Push and Twist (DC only)

*For applications requiring a higher IP rating, one of the above codes will be required.  
(See pages 10 and 11 for more details)*

VOLTAGE / CONNECTION		
CODE	DESCRIPTION	CONNECTION TYPE
<b>DC Voltages</b>		
D12WK1	12 VDC	DIN 43650 (Form A) Zinc-Nickel coating
D12WK7	12 VDC	Deutsch DT04-2P Zinc-Nickel coating
D12WK7D	12 VDC	Deutsch DT04-2P Bi-Directional Diode Zinc-Nickel coating
D14K1	14 VDC	DIN 43650 (Form A)
D24WK1	24 VDC	DIN 43650 (Form A) Zinc-Nickel coating
D24WK7	24 VDC	Deutsch DT04-2P Zinc-Nickel coating
D24WK7D	24 VDC	Deutsch DT04-2P Bi-Directional Diode Zinc-Nickel coating
D28K1	28 VDC	DIN 43650 (Form A)
D48K1	48 VDC	DIN 43650 (Form A)
D110K1	110 VDC	DIN 43650 (Form A)
D125K1	125 VDC	DIN 43650 (Form A)
D220K1	220 VDC	DIN 43650 (Form A)
<b>AC Voltages</b>		
A24K1	24 VAC	DIN 43650 (Form A)
A48K1	48 VAC	DIN 43650 (Form A)
A110K1	110-50Hz 120-60Hz	DIN 43650 (Form A)
A230K1	230-50Hz 240-60Hz	DIN 43650 (Form A)

*(See pages 10 and 11 for more details)*

TYPICAL ORDERING CODE:  
**VS6M-3A-A-D24WK1-B**

Please see Connectors Catalog  
Form #1027453

► **FUNCTIONS/SPOOL CODES:**

2 solenoids  
3 positions with spring centering

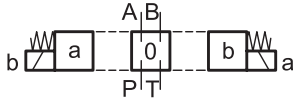

- 3A
- 3B
- 3F
- 3L
- 3J
- 3E
- 3H
- 3Q
- 3F1
- 3G
- 3K
- 3A1
- 3K1
- 3N
- 3E1
- 3R
- 3V
- 3S
- 3T

1 solenoid side A  
2 positions (central + external)  
with spring centering

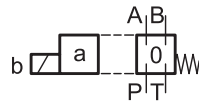

- 5A
- 5B
- 5F
- 5L

1 solenoid side B  
2 positions (central + external)  
with spring centering

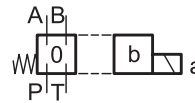

- 5A\*R
- 5B\*R
- 5F\*R
- 5L\*R

1 solenoid side A  
2 positions (external + central)  
with return spring

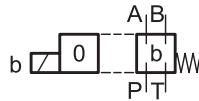

- 6A
- 6B
- 6F
- 6L

1 solenoid side B  
2 positions (external + central)  
with return spring

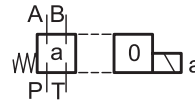

- 6A\*R
- 6B\*R
- 6F\*R
- 6L\*R

1 solenoid side A  
2 external positions with  
return spring

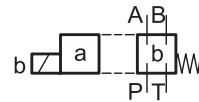

- 1A
- 1B

1 solenoid side B  
2 external positions with  
return spring

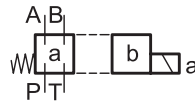

- 1A\*R
- 1B\*R

1 solenoid side A  
2 positions with return spring

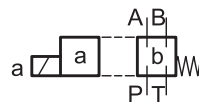

- 9X

1 solenoid side B  
2 positions with return spring

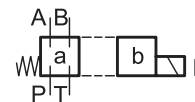

- 9X\*R

2 solenoids  
2 positions with mechanical retention

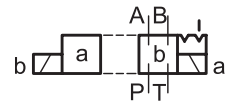

- 2A
- 2B
- 2AN
- 2AJ

Besides the diagrams shown, which are the most frequently used, other special versions are available: consult our technical department for their identification, feasibility and operating limits.

### ENERGIZED POSITION

## ► PERFORMANCE DATA:

### PRESSURE DROPS $\Delta p$ -Q

(obtained with viscosity 36 cSt at 50 °C)

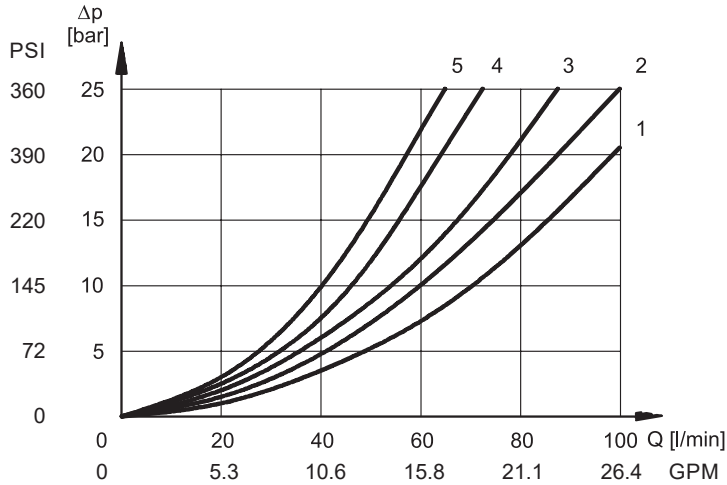

Refer to curve 5 for the pressure drops between working lines A and B of the spools 3G, 3R, 3V, 3S and 3T used in regenerative schemes.

SPOOL TYPE	FLOW DIRECTION			
	P → A	P → B	A → T	B → T
	CURVES ON GRAPH			
3A, 5A	2	2	3	3
3B, 5B	1	1	3	3
3F, 5F, 6F	3	3	1	1
3L, 5L, 6L	5	5	5	5
3J	2	1	3	3
3E	2	2	3	1
3H, 3Q	4	5	5	5
3FI	2	2	3	3
3G	1	3	1	3
3K	2	2	1	3
3AI, 3KI, 3EI	2	2	3	3
3N	1	2	3	3
3R, 3S	1	5	2	
3V, 3S	5	1		2
1A	3	3	3	3
1B	2	2	2	2
9X	3	3		
2A, 2B, 2AW, 2AJ	2	2	2	2

### DE-ENERGIZED POSITION

SPOOL TYPE	FLOW DIRECTION				
	P → A	P → B	A → T	B → T	P → T
	CURVES ON GRAPH				
3B, 5B					2
3F, 5F, 6F			3	3	
3L, 5L, 6L, S4					5
3J		4			
3E				3	
3H, 3Q			6	6	3
3G	3	3			
3K			3		
3N	4				
3S, 3T			3	3	

## SWITCHING TIMES

The values indicated are obtained according to ISO 6403 standard, with mineral oil viscosity 36 cSt at 50°C.

SPOOL TYPE	TIMES [MS]	
	ENERGIZING	DE-ENERGIZING
DC	25 - 75	15 - 25
AC	10 - 25	15 - 40

► **PERFORMANCE DATA: Operating Limits**

The curves define the flow rate operating fields according to the valve pressure of the different versions. The values have been obtained according to ISO 6403 norm with solenoids at rated temperature and supplied with voltage equal to 90% of the nominal voltage. The value have been obtained with mineral oil, viscosity 36 cSt, temperature 50 °C and filtration according to ISO 4406:1999 class 18/16/13.

The limits for 1B and 1A spools refer to the 4-way operation. The operating limits of a 4-way valve in 3-way operation or with port A or B plugged or without flow are shown in the chart on the next page. The performance of the DC solenoid powered by AC with rectifier connectors are on page 6.

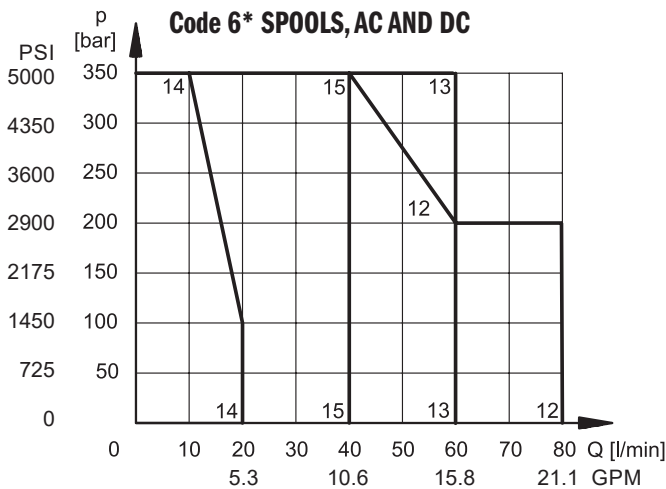
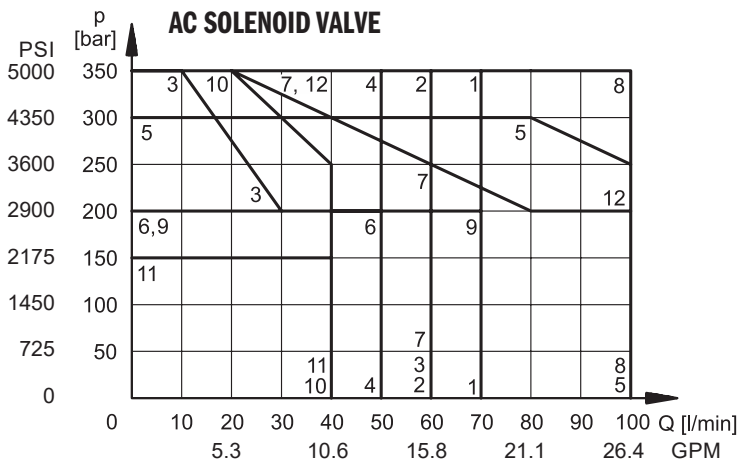
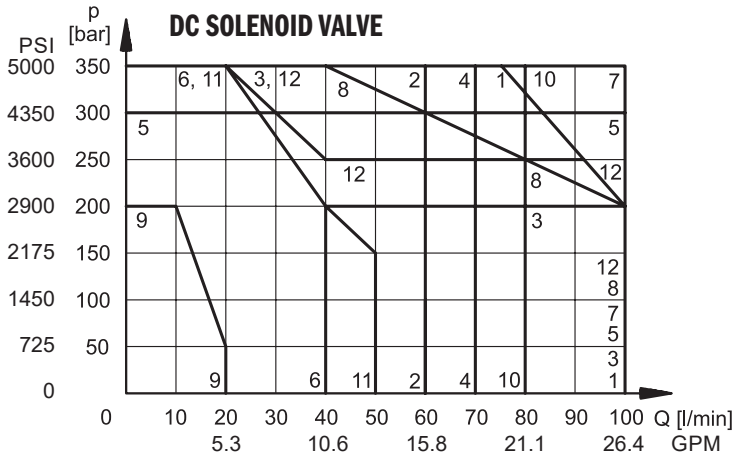

**DC SOLENOID VALVE**

SPOOL	CURVE	
	P → A	P → B
3A, 5A	1	1
3B, 5B	2	2
3F, 5F	3	3
3L, 5L	4	4
3J	5	5
3E	4	6
3H	4	4
3Q	4	4
3FI	7	7
3G	7	7
3K	4	6
3AI	1	1
3KI	4	4
3N	5	5
3EI	4	4
3R	6*	6
3V	6	6*
3S	6	6
3T	6	6
1A	7	7
1B	8	8
2A	7	7
2B	8	8
2AN, 2AJ	7	7

**AC SOLENOID VALVE**

SPOOL	CURVE	
	P → A	P → B
3A, 5A	1	1
3B, 5B	2	2
3F, 5F	3	3
3L, 5L	2	2
3J	5	5
3E	6	6
3H	4	4
3Q	4	4
3FI	7	7
3G	8	8
3K	6	6
3AI	2	2
3KI	7	7
3N	5	5
3EI	7	7
3R	10*	10
3V	10	10*
3S	10*	10
3T	10	11*
1A	1	1
1B	1	1
2A	8	8
2B	9	9
2AN, 2AJ	8	8

\* Performance obtained for a valve with A and B lines connected the one to the piston-side chamber and the other to the rod-side chamber of a double-acting cylinder with area ratio 2:1.

SPOOL	CURVE
6A	12
6B	13
6F	14
6L	15

**► PERFORMANCE DATA:**
**4-way valve in 3-way operation**

Operating limits of a 4-way valve in 3-way operation or with port A or B plugged or without flow.

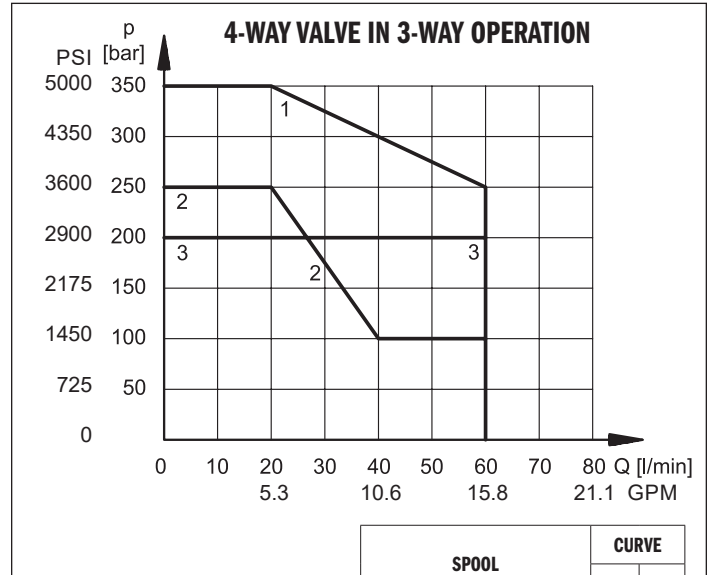
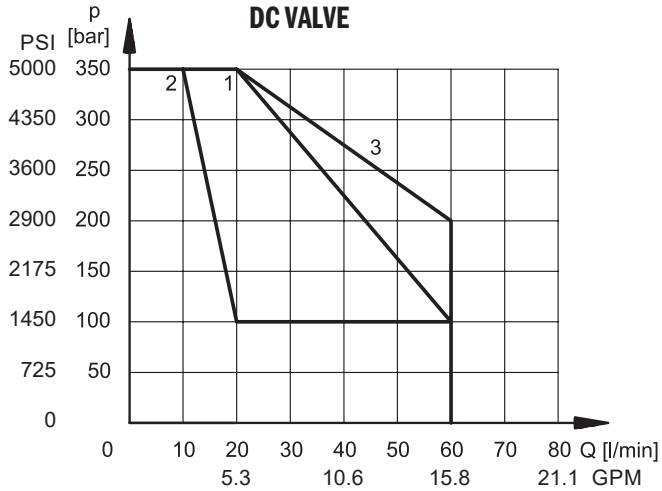
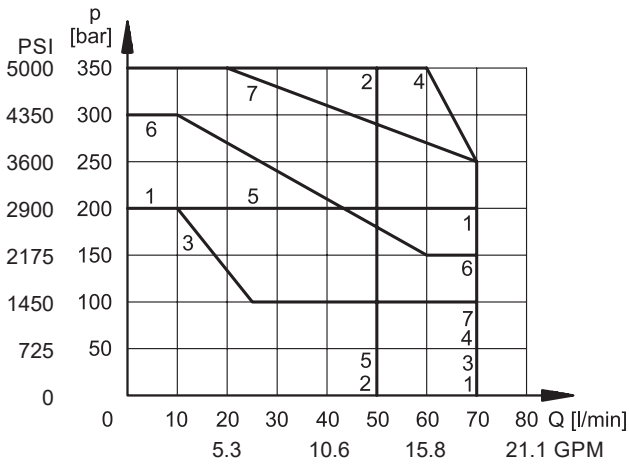
**AC solenoid valve with coil A110 fed with 110V - 60 Hz**

SPOOL	CURVE	
	P → A	P → B
3A, 5A	1	1
3B, 5B	2	2
3F, 5F	3	3
3L, 5L	4	4
3FI	5	5
1A	2	2
2A	6	6

SPOOL	CURVE	
	DC	AC
1A backpr. A; 1A-*R backpr. B	1	1
1B backpr. A; 1B-*R backpr. B	1	1
1A backpr. B; 1A-*R backpr. A	2	1
1B backpr. B; 1B-*R backpr. A	3	3

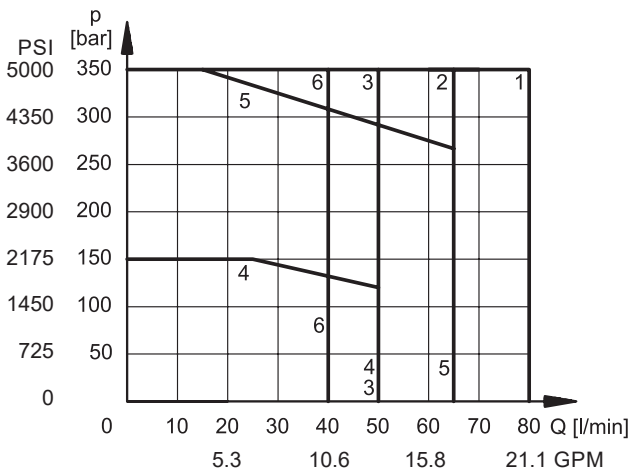
**Operating limits for DC solenoid valves fed with AC with rectifier connector: VEA-6FR-A (1008400)**

SPOOL	CURVE	
	P → A	P → B
3A, 5A	2	2
3B, 5B	3	3
3F, 5F	4	4
3L, 5L	2	2
3FI	5	5
1A	6	6
2A	1	1

**► INSTALLATION DATA:**

Dimensions mm [in]

**OVERALL AND MOUNTING DIMENSIONS FOR DC SOLENOID VALVES**

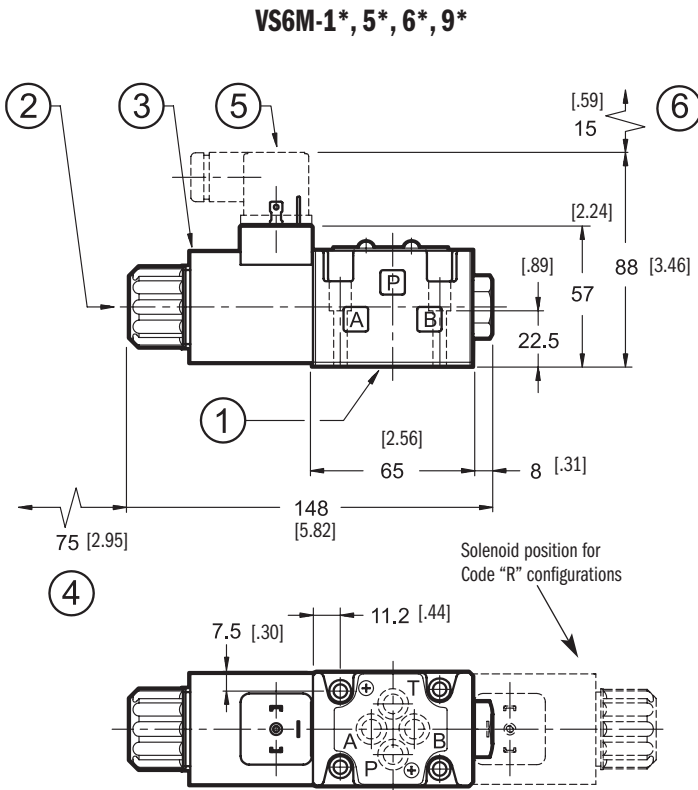
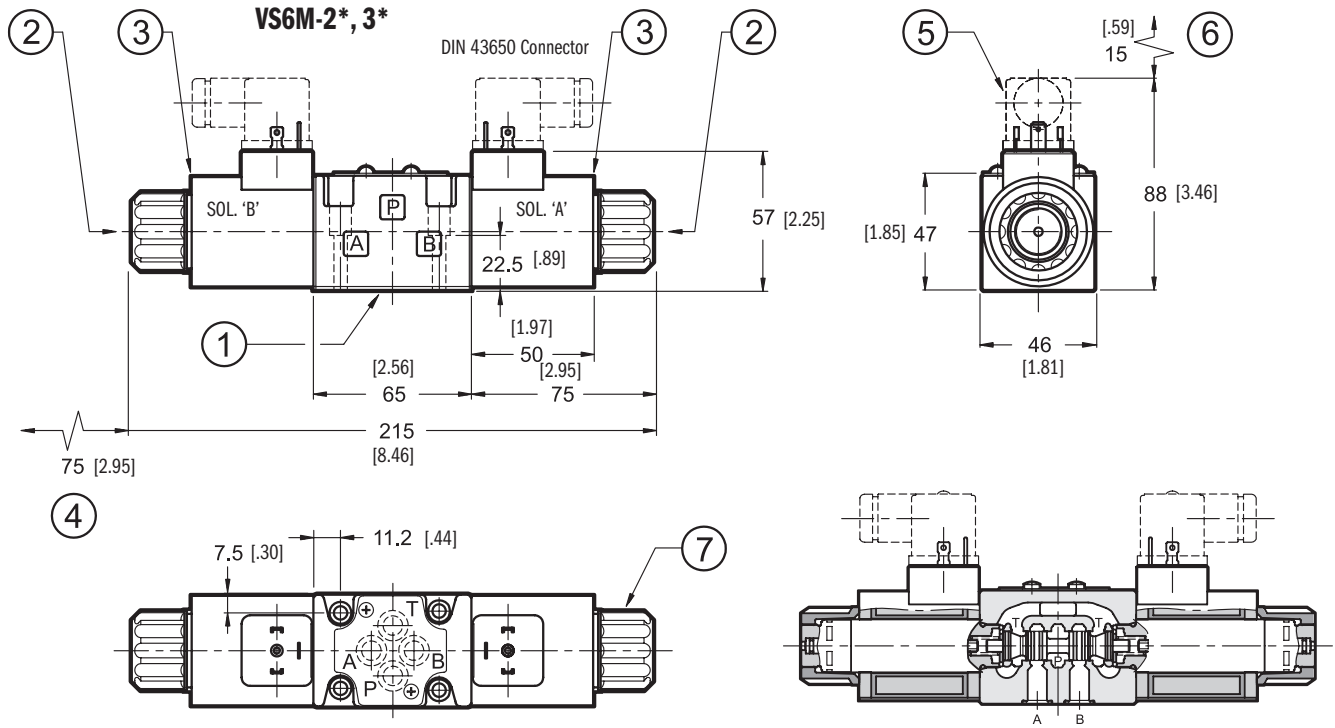

Valve fastening: BD03-125  
Tightening torque: 4-6 lb-ft (5.4 - 8 Nm)

1	Mounting surface with sealing rings: 4pcs of AS568-012 90 Shore A
2	Standard manual override included in the solenoid tube
3	Coil (360° revolving)
4	Coil removal space
5	EN 175301-803 (ex DIN 43650) connector to be ordered separately.
6	Connector removal space
7	Locking ring: tightening torque 4 lb-ft (5 Nm)

**► INSTALLATION DATA:**

Dimensions mm [in]

**OVERALL AND MOUNTING DIMENSIONS FOR AC SOLENOID VALVES**

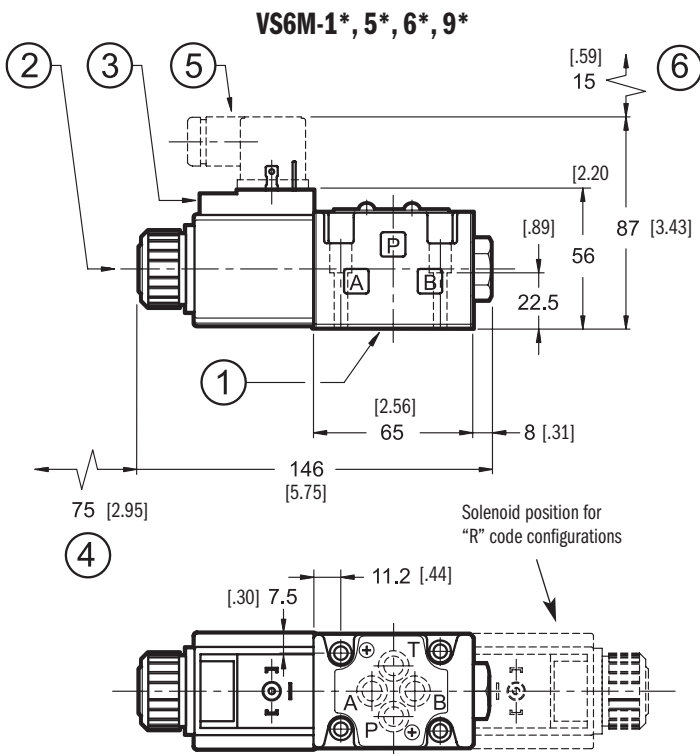
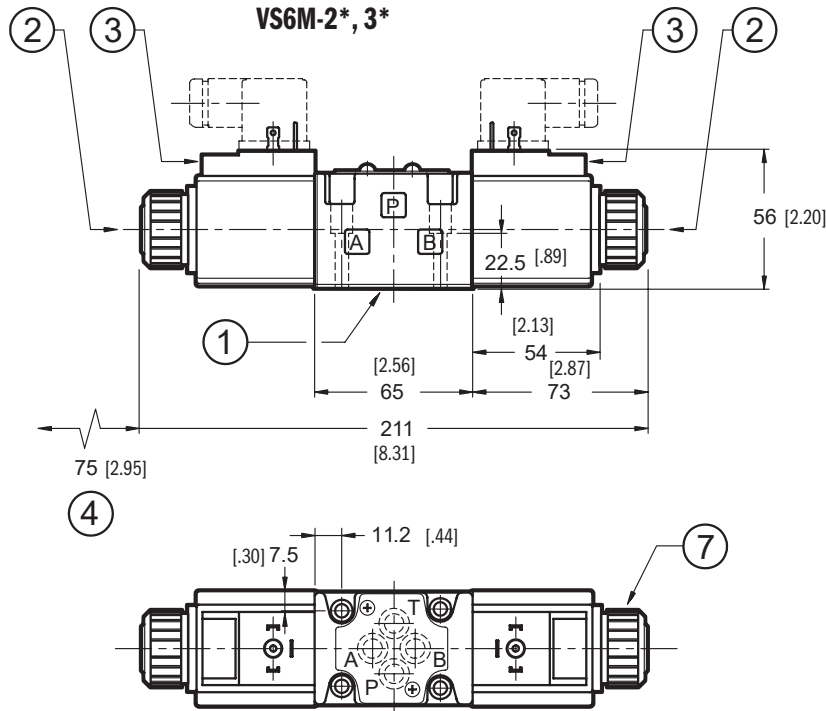

Valve fastening: BD03-125  
Tightening torque: 4-6 lb-ft (5.4 - 8 Nm)

1	Mounting surface with sealing rings: 4pcs of AS568-012 90 Shore A
2	Standard manual override included in the solenoid tube
3	Coil (360° revolving)
4	Coil removal space
5	EN 175301-803 (ex DIN 43650) connector to be ordered separately.
6	Connector removal space
7	Locking ring: tightening torque 4 lb-ft (5 Nm)



► **ELECTRICAL:**

**CONNECTIONS**

See Connectors and Cable Sets Catalog (1027453) for all available connection styles.

Connection for EN 175301-803  
(ex DIN 43650) connector  
code WK1 (DC voltage version only)

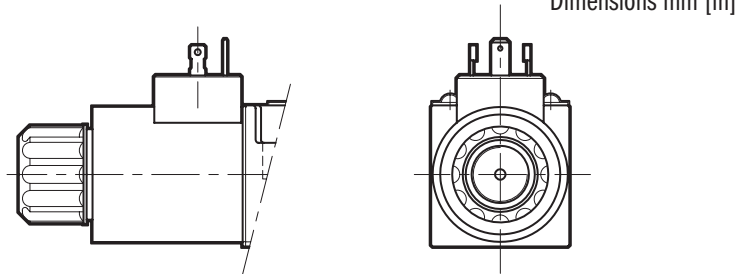

Connection for  
DEUTSCH DT06-2S male connector  
code WK7  
code WK7D (with diode)



**Solenoids**

These are essentially made up of two parts: tube and coil. The tube is threaded into the valve body and includes the armature that moves immersed in oil, without wear. The inner part, in contact with the oil in the return line, ensures heat dissipation. The coil is fastened to the tube by a threaded ring, and can be rotated 360°, to suit the available space.

NOTE: In order to further reduce the emissions, with DC supply, use of type H connectors is recommended. These prevent voltage peaks on opening of the coil supply electrical circuit.

<b>SUPPLY VOLTAGE FLUCTUATION</b>	± 10% Vnom
<b>MAX SWITCH ON FREQUENCY</b>	18.000 ins/hr
<b>DUTY CYCLE</b>	100%
<b>ELECTROMAGNETIC COMPATIBILITY (EMC) (NOTE)</b>	In compliance with 2014/30/EU
<b>LOW VOLTAGE</b>	In compliance with 2014/35/EU
<b>CLASS OF PROTECTION:</b> Coil insulation (VDE 0580) Impregnation: DC valve AC valve	class H class F class H

## ► ELECTRICAL:

### Protection from atmospheric agents IEC 60529

The IP protection degree is guaranteed only with both valve and connectors of an equivalent IP degree, correctly connected and installed.

Electric Connection Code	Electric Connection Protection	Whole Valve Protection
<b>K1</b>	IP65	IP65
<b>WK1</b>	IP66	IP66
<b>WK7</b>	IP66/IP68/IP69 IP69K*	IP66/IP68/IP69 IP69K*
<b>WK7D</b>	IP66/IP68/IP69 IP69K*	IP66/IP68/IP69 IP69K*

(\*) The IP69K protection degree is not taken in account in IEC 60529 but is included in ISO 20653.

### Current and absorbed power for DC solenoid valves

The coils WK feature a zinc-nickel surface treatment.

The WK7D coil includes a bi-directional diode for protection from voltage peaks during switching. During the switching the diode significantly reduces the energy released by the winding, but limiting the voltage to 31.4 V in the D12 coil and to 58.9 V in the D24 coil.

Using connectors type "D" (VEA-6FR) with embedded bridge rectifier it is possible to feed DC coils (starting from 48V voltage) with alternating current (50 or 60 Hz), considering a reduction of the operating limits (see page 6).

Code	Nominal Voltage [V]	Resistance at 20 °C [Ω]	Current Consumption [A]	Power Consumption [W]	Replacment Coil Code
<b>D12WK1</b>	12	4.4	2.72	32.7	M3984000001
<b>D12WK7</b>	12	4.4	2.72	32.7	M3984000101
<b>D12WK7D</b>	12	4.4	2.72	32.7	M3984000111
<b>D14K1</b>	14	7.2	1.93	27	M1903086
<b>D24WK1</b>	24	18.6	1.29	31	M3984000002
<b>D24WK7</b>	24	18.6	1.29	31	M3984000102
<b>D24WK7D</b>	24	18.6	1.29	31	M3984000112
<b>D28K1</b>	28	26	1.11	31	M1903082
<b>D48K1</b>	48	78.6	0.61	29.5	M1903083
<b>D110K1</b>	110	423	0.26	28.2	M1903464
<b>D125K1</b>	125	550	0.23	28.6	M1903467
<b>D220K1</b>	220	1692	0.13	28.2	M1903465

### Current and absorbed power for AC solenoid valve

The table shows current and power consumption values at inrush and at holding, for AC coils.

**Coils for alternating current (values ± 5%).**

Suffix	Nominal voltage [V]	Freq. [Hz]	Resistance at 20 °C [Ω]	Current consumption at inrush [A]	Current consumption at holding [A]	Power consumption at inrush [VA]	Power consumption at holding [VA]	Coil code [K1]
<b>A24K1</b>	24	50	1,69	5,81	1,32	139	32	M1902830
<b>A48K1</b>	48		6,02	3,78	0,86	182	41	M1902831
<b>A110K1</b>	110V-50Hz 120V-60Hz	50/60	33	1,76	0,40	194	44	M1902832
				1,54	0,35	185	42	
<b>A230K1</b>	230V-50Hz 240V-60Hz		135	0,92	0,21	213	48	M1902833
				0,79	0,18	190	43	

► **MANUAL OVERRIDES:**

Dimensions mm [in]

**Manual override, boot protected**

**U - Version for DC solenoid valve**

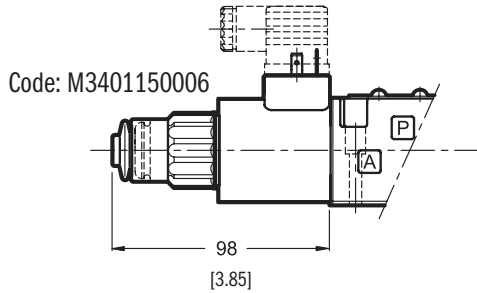

**U - Version for AC solenoid valve**

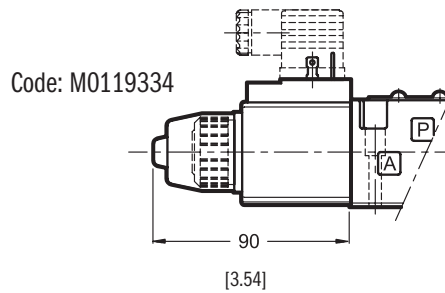

**H Lever manual override**

(only for DC solenoid valve)

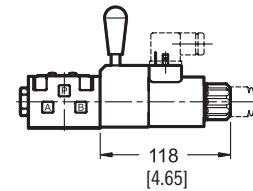
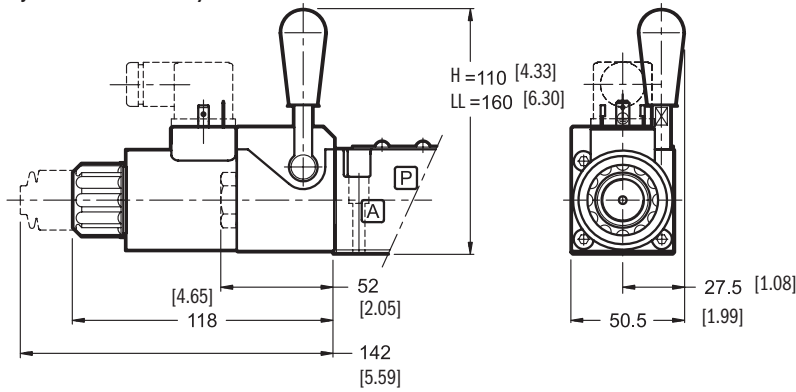

NOTES: the CH device is located on the A side of the valve, with the exception of the valves type VS6M-\*R.

Not available on function code 6 valves.

**CP Push manual override**

(only for DC solenoid valve)

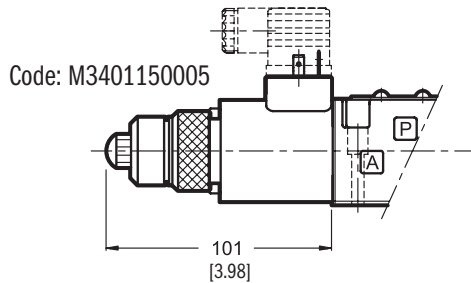

**CK1 knob manual override, turning**

(only for DC solenoid valve)

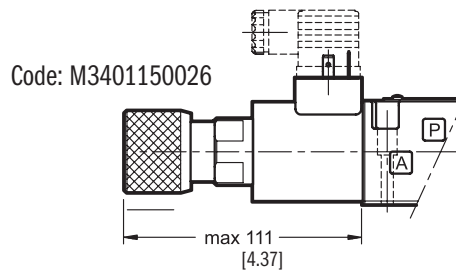

**CPK Push manual override with mechanical retention**

(only for DC solenoid valve)

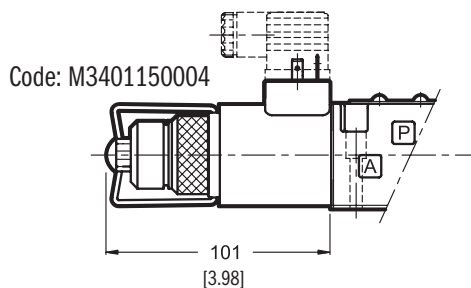

**CK2 and twist manual override**

(only for DC solenoid valve)

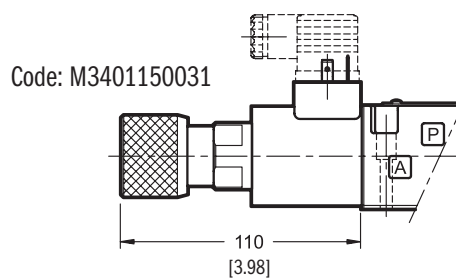

### ► INSTALLATION DATA:

#### PORT RESTRICTIONS

Port restrictors are recommended if flow variations which exceed the valve performance limit during the switching processes occur, or for circuit dampening.

Port restrictor plugs can be ordered separately with the part numbers shown at right.

Ø(mm)	PART NUMBER	Ø(mm)	PART NUMBER
blank	M0144162	1.2	M0144035
0.6	M0144163	1.5	M0144036
0.8	M0144033	1.8	M0144164
1	M0144034	2	M0144165

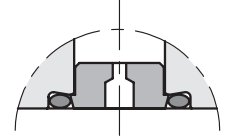

#### INSTALLATION

Configurations with centering and return springs can be mounted in any position; code 2 valves - without springs and with mechanical detent - must be mounted with the longitudinal axis horizontal.

Valve fixing takes place by means of screws or tie rods, with the valve mounted on a lapped surface, with values of planarity and smoothness that are equal to or better than those indicated in the drawing. If the minimum values of planarity and/or smoothness are not met, fluid leakages between valve and mounting surface can easily occur.

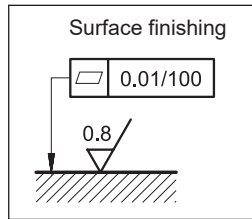

#### MOUNTING SURFACE

NFPA D03  
ISO 4401-03-02-0-05  
(CETOP 4.2-4-03-350)

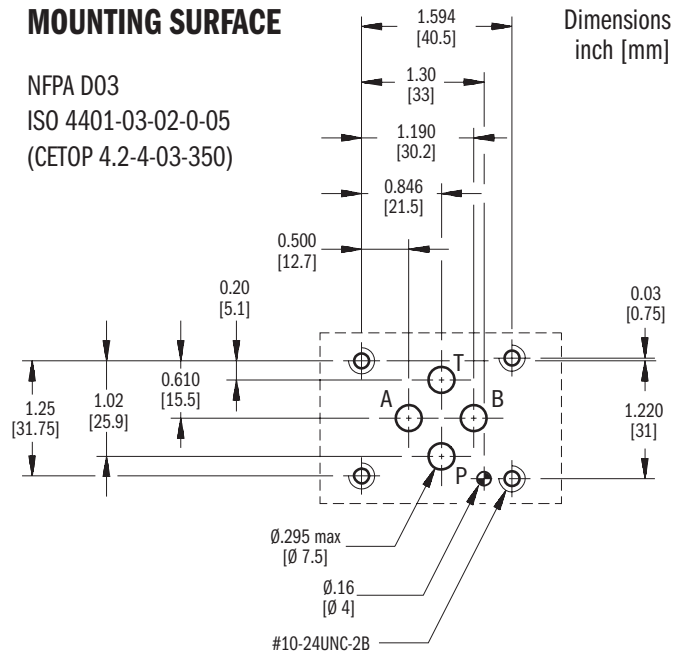

#### SEAL KIT

BUNA SEAL KIT	1013188
VITON SEAL KIT	1013096

#### BOLT KIT

BD03-125 (Valve Only)	1008406
-----------------------	---------

#### NOTES:

1. Bolt kit consists of: Qty. 4 10-24NC x 1.25 inch screws / Qty. 4 #10 Lock washer
2. The recommended torque value for fasteners is: 4 lb.ft (5.4 Nm)



**CONNECTORIAL** VALVE ACCESSORIES  
Connectors and Cable Sets

**Connectors and Cable Sets**  
Standard Directional Control Valves

**Male Receptacles**

- VEA-3C-A (3 PIN) 1001848
- VEA-3MH-A (3 PIN) 1001849
- VEA-3LA-A (M2 LA PIN) 1001850

**Female Receptacles**

- VEA-3M-A (3 PIN) 1004515
- VEA-3D-A (3 PIN) 1004515
- VEA-3L-A (M2 LA PIN) 1004514
- VEA-DT06-CS-A (Deutsch) 1004509C

**DIN Connector** 43650 Form A / ISO 4400

- VEA-3E-A (Grey) 1005039
- VEA-3F-A (Black) 1005038

**Cable Glands** VSD-HL-402

**PC11-SD** Strain Relief

1027453 Rev 02 1/5

CONTINENTAL HYDRAULICS INC. / HYDRECO INC.

4895 12th Avenue East, Shakopee, Minnesota 55379

952.895.6400 • sales@conthyd.com • www.continentalhydraulics.com • www.hydreco.com

© 2023 CONTINENTAL HYDRAULICS Inc., All Rights Reserved. Product specifications and appearance are subject to change without notice.

www.continentalhydraulics.com • sales@conthyd.com

Connectors and Cable Sets

Form #1027453