

# VSD05M

## Solenoid Operated Directional Valve

SUBPLATE MOUNTING  
ISO 4401-05

P max 4600 PSI 320 bar  
Q max 38 GPM 145 l/min

### ► DESCRIPTION:

These valves conform to NFPA D05 and ISO 4401 mounting standards. They are available in both 3 way and 4 way styles.

All versions are available in 2 position spring offset, 2 position detent, 2 position spring centered and 3 position spring centered versions.

A wide range of spools are available.

VSD05M-3L-GB-60L-B



VSD05M-3A-A-44L-B

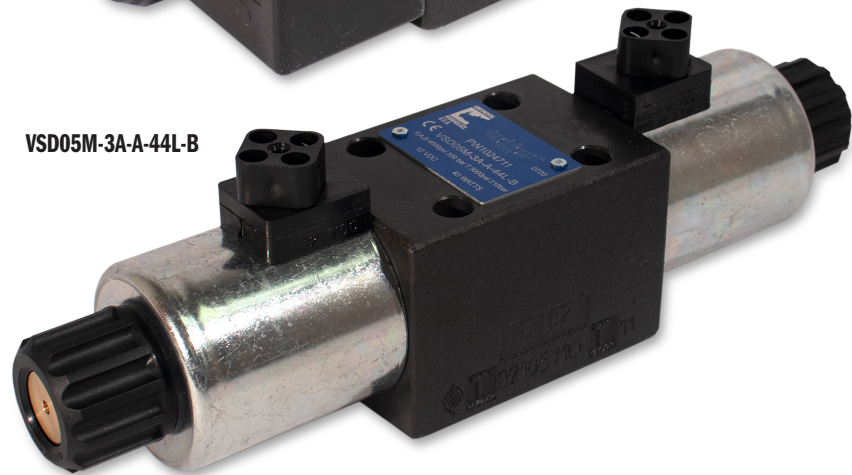

### ► PERFORMANCE:

Max Operating Pressure:	P - A - B Ports	Standard	4600 psi	320 bar
		DC STD	3000 psi	210 bar
	T Port	AC ALL	2000 psi	140 bar
Flowrate	DC		38 gpm	145 l/min
	AC		32 gpm	120 l/min
Mounting Surface		NFPA D05 ISO 4401-05-04-0-05		
Maximum Weight	AC		8 lbs	3.6 kg
	DC		10.6 lbs	4.8 kg
Temperature Range	Ambient		-4 to +130°F	-20 to +54°F
Fluid Temperature Range	Standard		-4 to +180°F	-20 to +82°F
Fluid Viscosity	Range		60-1900 SUS	10-400 cSt
	Recommended		120 SUS	25 cSt
Fluid Contamination Degree		ISO 4406:1999 Class 20/18/15		

(Obtained with mineral oil with viscosity of 36 cSt at 50°C and electronic control card)

## VSD05M

### ► IDENTIFICATION CODE:

**VSD05M** - [ ] [ ] - [ ] [ ] - [ ] [ ] ————— DESIGN LETTER

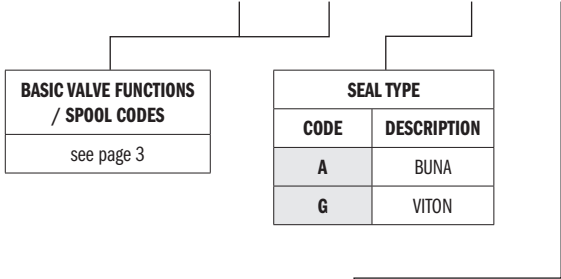

BASIC VALVE FUNCTIONS / SPOOL CODES
see page 3

SEAL TYPE	
CODE	DESCRIPTION
A	BUNA
G	VITON

MECHANICAL (SELECT 1)	
CODE	DESCRIPTION
OMIT	No options
R	Single Solenoid - B port end
WD	Wash-Down

VALVES REQUIRING TERMINAL BOX CONNECTIONS		
<i>Reference Page</i>		
CODE	VOLTAGE	CONNECTION TYPE
<b>B-60L</b>	120 - 60hz 110 - 50hz	Connection Box with terminal post and lights
<b>B-61L</b>	240 - 60hz 220 - 50hz	
<b>B-68L (Low Force)</b>	120 - 60hz 110 - 50hz	
<b>B3H-60L</b>	120 - 60hz 110 - 50hz	Single Solenoid Box with 3 PIN MALE MINI RECEPTACLE CONNECTOR ON "B" PORT END
<b>B3H-68L (Low Force)</b>	120 - 60hz 110 - 50hz	
<b>B3A-60L</b>	120 - 60hz 110 - 50hz	Single Solenoid Box with 3 PIN MALE MINI RECEPTACLE CONNECTOR ON "A" PORT END
<b>B3A-61L</b>	240 - 60hz 220 - 50hz	
<b>B3A-68L (Low Force)</b>	120 - 60hz 110 - 50hz	
<b>B5H-60L</b>	120 - 60hz 110 - 50hz	Box with 5 PIN MALE MINI RECEPTACLE CONNECTOR ON "B" PORT END
<b>B5H-61L</b>	240 - 60hz 220 - 50hz	
<b>B5H-68L (Low Force)</b>	120 - 60hz 110 - 50hz	
<b>B5A-60L</b>	120 - 60hz 110 - 50hz	Box with 5 PIN MALE MINI RECEPTACLE CONNECTOR ON "A" PORT END
<b>B5A-61L</b>	240 - 60hz 220 - 50hz	
<b>B5A-68L (Low Force)</b>	120 - 60hz 110 - 50hz	

DIN / DEUTSCH COIL CONNECTION		
<i>Reference Page</i>		
CODE	VOLTAGE	CONNECTION TYPE
<b>33L</b>	120 - 60hz 110 - 50hz	DIN 43650 (Form A)
<b>34L</b>	240 - 60hz 220 - 50hz	
<b>42L</b>	24 Volt DC	
<b>44L</b>	12 Volt DC	Deutsch DT04-2P
<b>D12K7</b>	12 Volt DC	
<b>D24K7</b>	24 Volt DC	

TYPICAL ORDERING CODE:  
**VSD05M-3A-GB-60L**

Please see Connectors Catalog  
Form #1027453

► **FUNCTIONS/SPOOL CODES:**

2 solenoids  
3 positions with spring centering

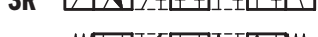
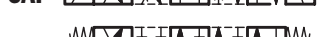
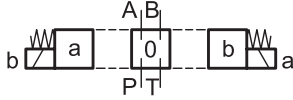

1 solenoid side A  
2 positions (central + external)  
with spring centering

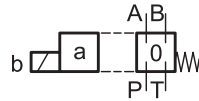

1 solenoid side B  
2 positions (central + external)  
with spring centering

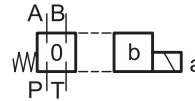

1 solenoid side A  
2 positions (external + central)  
with return spring

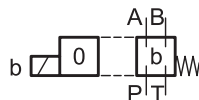

1 solenoid side B  
2 positions (external + central)  
with return spring

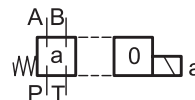

1 solenoid side A  
2 external positions with  
return spring

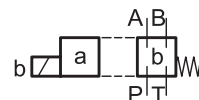

1 solenoid side B  
2 external positions with  
return spring

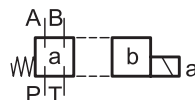

1 solenoid side A  
2 positions with return spring

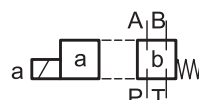

1 solenoid side B  
2 positions with return spring

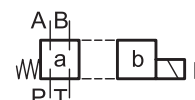

2 solenoids  
2 positions with mechanical retention

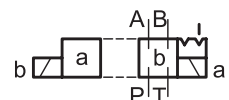

Besides the diagrams shown, which are the most frequently used, other special versions are available: consult our technical department for their identification, feasibility and operating limits.

**► PERFORMANCE DATA:**
**PRESSURE DROPS  $\Delta p$ -Q Shifted Valve**

(Obtained with viscosity of 170 SUS - 36 CST at 70°F - 50°C)

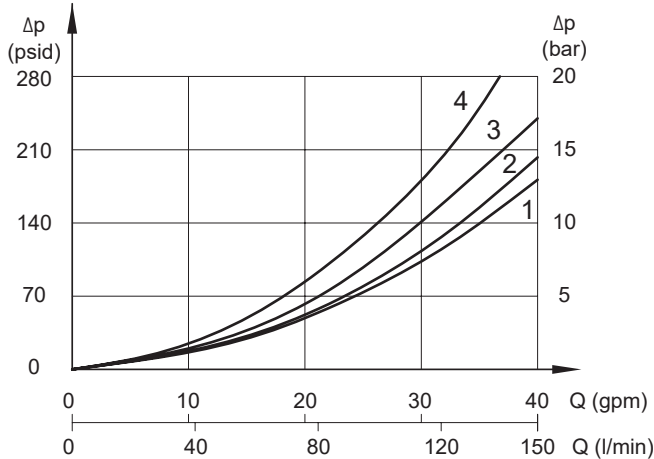

SPOOL TYPE	FLOW DIRECTION			
	P → A	P → B	A → T	B → T
	CURVES ON GRAPH			
A, A1	2	2	1	1
B	3	3	1	1
E, F, F1, K, 1A, 2A, 1B, 2B	3	3	2	2
H, L Q	1	1	2	2
G	1	1	1	1

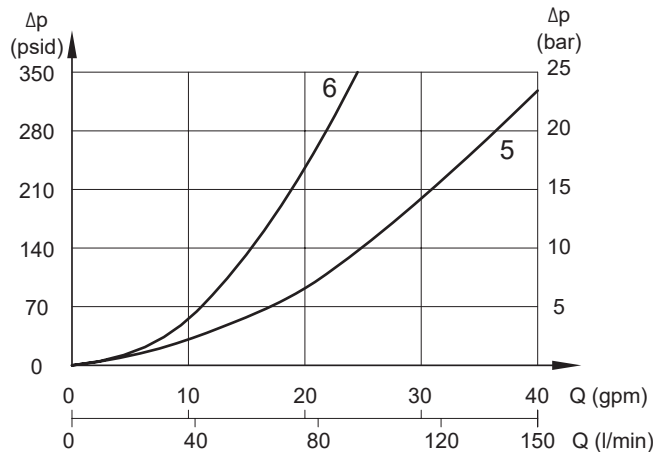
**PRESSURE DROPS  $\Delta p$ -Q CENTRAL POSITION**

SPOOL TYPE	FLOW DIRECTION				
	P → A	P → B	A → T	B → T	P → T
	CURVES ON GRAPH				
B, L H, Q					6
E				6	
F			6	6	
G	3	3			
K			6		

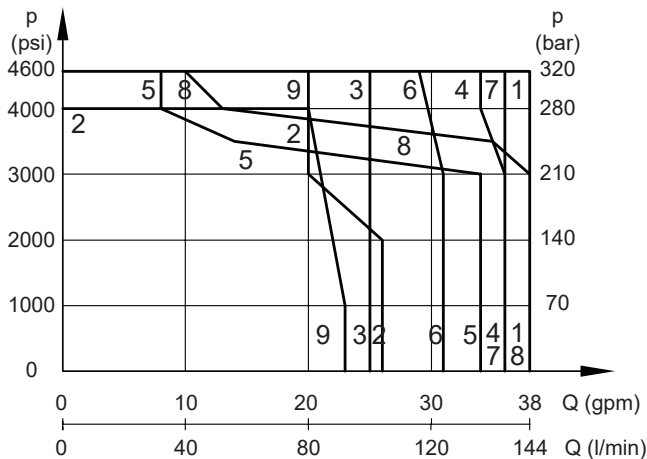
**PERFORMANCE CURVE - DC VOLTAGE**

CURVE	SPOOL
1	A, B, G, 9X
2	L
3	1A
4	1A-R
5	F
6	1B
7	F1
8	E, K
9	H, Q

► **PERFORMANCE DATA:**

**AC VOLTAGE**

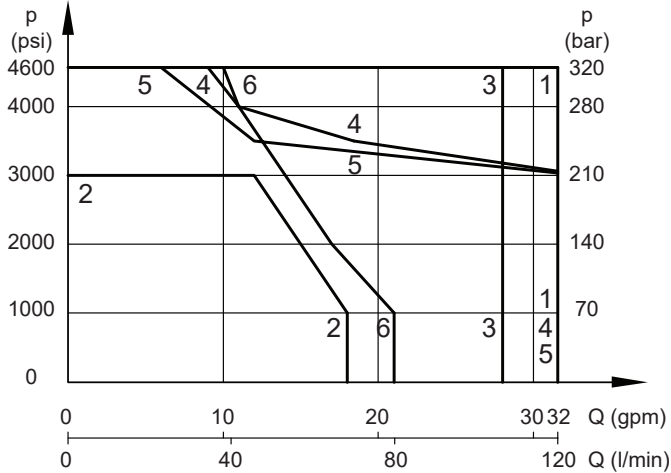

CURVE	SPOOL
1	A, B, G, 9X
2	L
3	1A
4	F, F1
5	K, E
6	H, Q

**AC VOLTAGE - LOW FORCE**

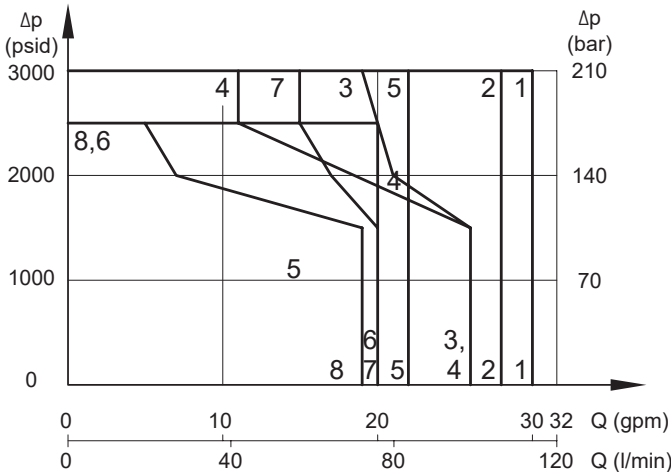

CURVE	SPOOL
1	1B, 2B, G
2	1B-R
3	1A
4	1A-R
5	B
6	A
7	2A
8	F

NOTES:

1. The values indicated in the graphs are relevant to the standard valve. The DC Performance Curve used a 42L coil, the AC Performance Curve used a 60L coil, and the AC Low Force Curve used a 68L coil.
2. Valve performance was tested in a four way circuit (full loop). Performances may be reduced from that shown when used in a three-way circuit (half circuit), i.e. A or B port plugged.
3. The values have been obtained according to ISO 6403 norm with solenoids at rated temperature and supplied with voltage equal to 90% of the nominal voltage. The value have been obtained with filtration according to ISO 4406:1999 class 18/16/13.

**► INSTALLATION DATA:**

Dimensions mm [in]

**OVERALL AND MOUNTING DIMENSIONS - CONNECTION BOX VERSION**

**VSD05M-2\*, 3\***

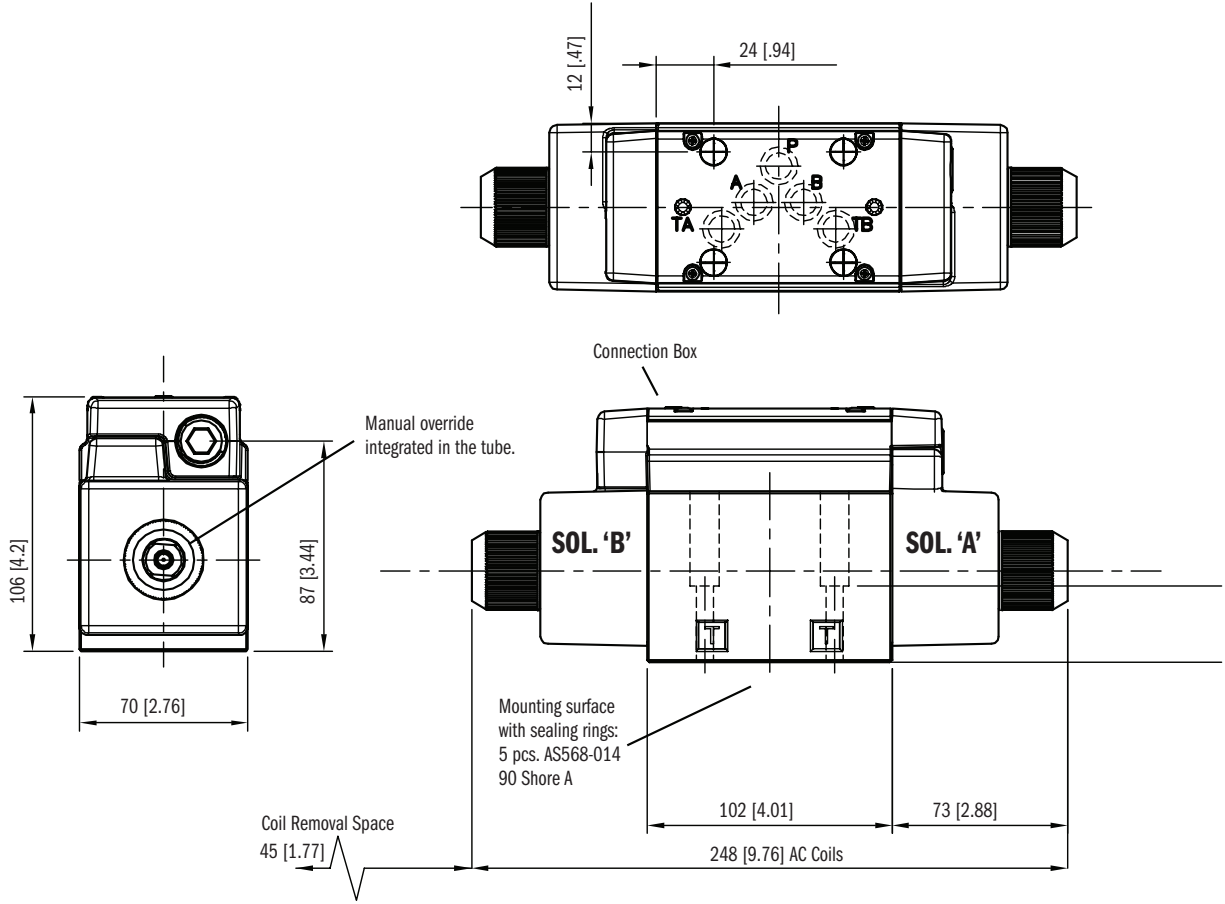

**VSD05M-1\*, 5\*, 6\*, 9\***

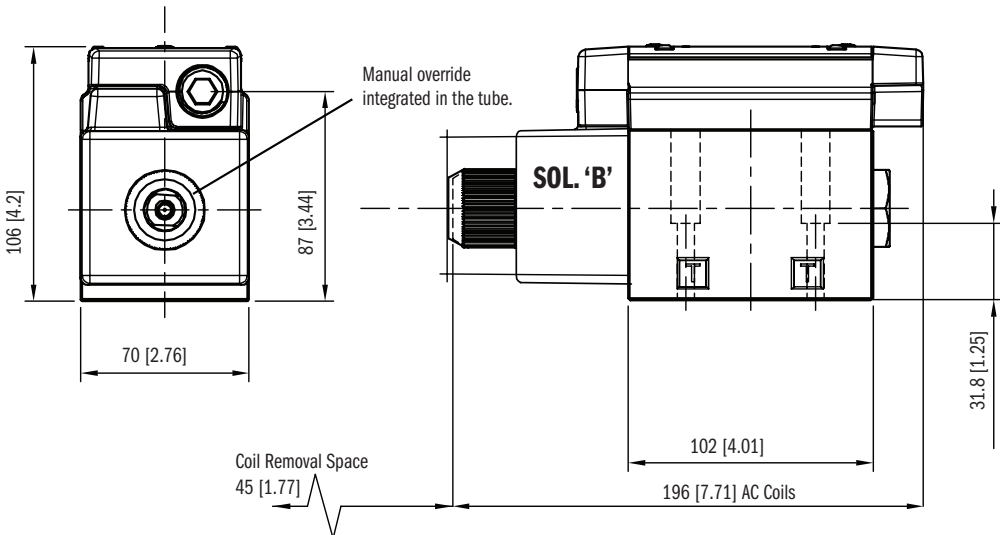

**► INSTALLATION DATA:**

Dimensions mm [in]

**OVERALL AND MOUNTING DIMENSIONS - DIN STYLE VERSION**

**VSD05M-2\*, 3\***

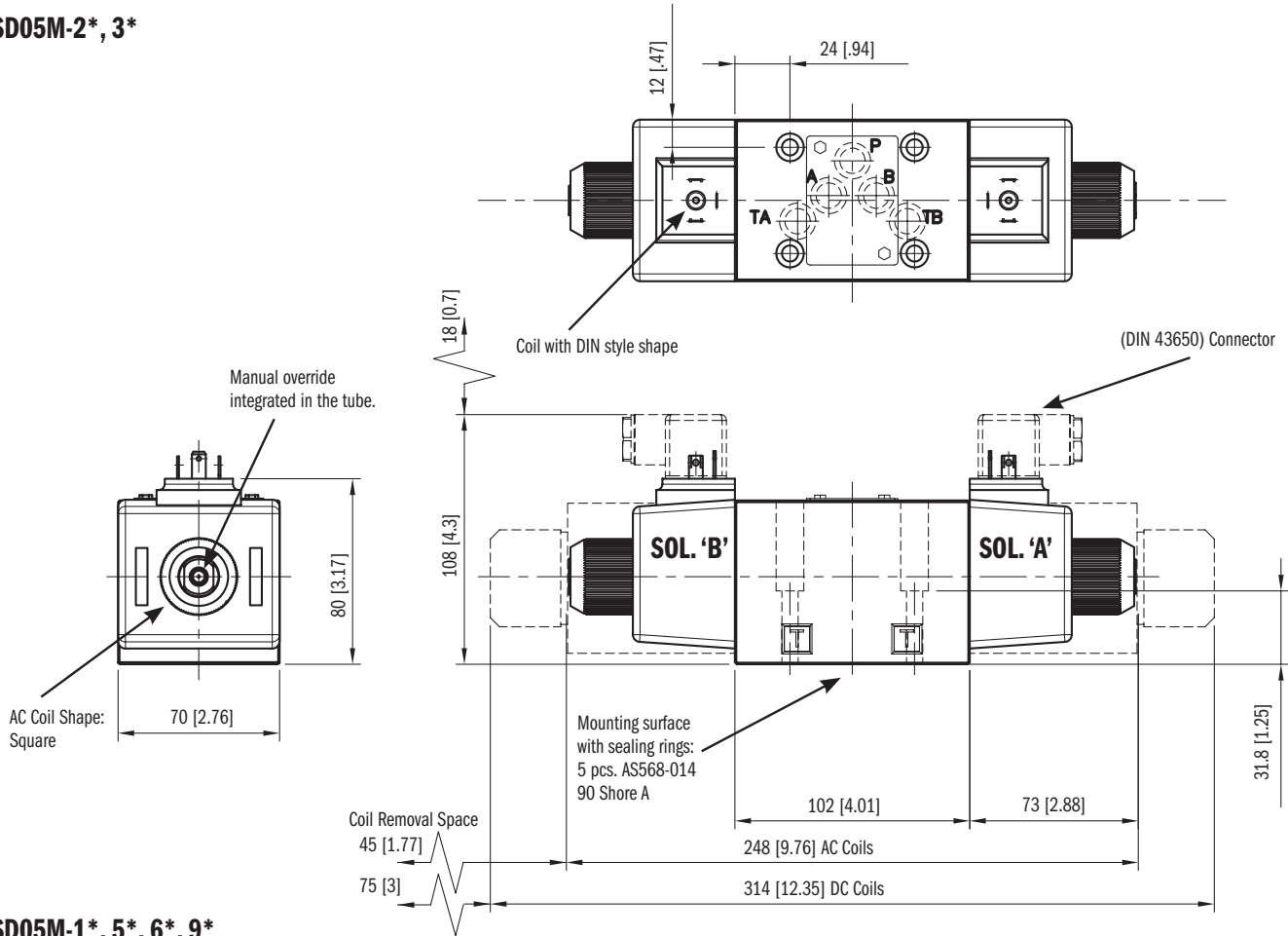

**VSD05M-1\*, 5\*, 6\*, 9\***

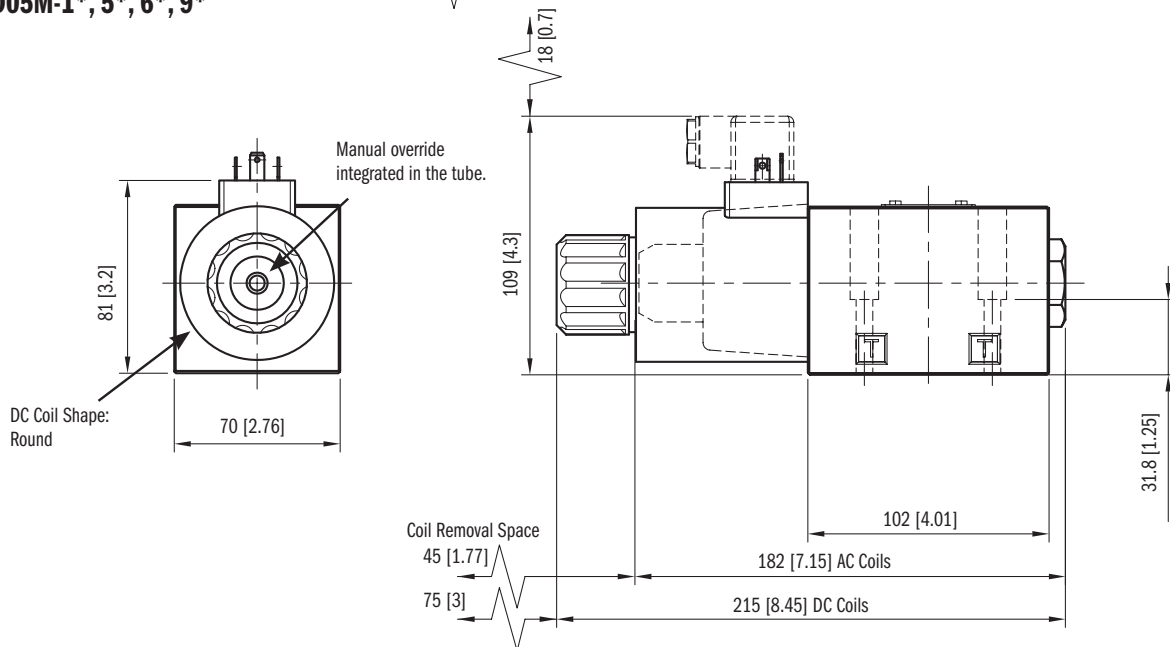

## ► SOLENOIDS:

Listed below the types of solenoids available and the numbers to be added in the solenoid box on page 3.

### CONNECTION BOX SOLENOIDS

This is a two pin solinoid which connects to the circuit board. Wiring is done on the terminal strip inside the box.

BOX CONNECTION COIL CODE	VOLTAGE & FREQ. [VOLT - HERTZ]	VOLTAGE LIMITS [MIN - MAX]	RESISTANCE ±10% [OHM]	INRUSH CURRENT [A]	HOLDING CURRENT [A]	HOLDING POWER [W]	REPLACEMENT COIL
60L	120 - 60 110 - 50	108 - 126 99 - 116	9.2	5 6.2	0.91 1.1	45 43	450980AD
61L	240 - 60 220 - 50	216 - 252 198 - 231	38	2.9 3	0.48 0.53	45 43	450980AC
68L (Low Force)	120 - 60 110 - 50	108 - 126 99 - 116	16.4	3.7 3.8	0.38 0.41	22 21	450980AB

### DIN SOLENOID

#### DIN 43650 FORM A

This solenoid has three terminal posts. Use bi-polar connectors that meet ISO 4400 / DIN 43650 (EN 175301). Protection against atmospheric agent: IP 65

DIN CONNECTION COIL CODE	VOLTAGE & FREQ. [VOLT - HERTZ]	VOLTAGE LIMITS [MIN - MAX]	RESISTANCE ±10% [OHM]	INRUSH CURRENT [A]	HOLDING CURRENT [A]	HOLDING POWER [W]	REPLACEMENT COIL
33L	120 - 60 110 - 50	108 - 126 99 - 116	9.2	5 6.2	0.91 1.1	45 43	307251
34L	240 - 60 220 - 50	216 - 252 198 - 231	38	2.9 3	0.48 0.53	45 43	307252
42L	24 V DC	21 - 26	14.2	1.68	1.68	40.3	M1902876
44L	12 V DC	10 - 13	3.1	3.87	3.87	45.8	M1902870

### DEUTSCH SOLENOIDS CONNECTIONS

This solenoid used for higher IP Protection ratings is Deutsch DT04-2P for male connectors type Deutsch DT06-2S (Available in 12 and 24 VDC voltages only).

DEUTSCH CONNECTION COIL CODE	VOLTAGE & FREQ. [VOLT - HERTZ]	VOLTAGE LIMITS [MIN - MAX]	RESISTANCE ±10% [OHM]	INRUSH CURRENT [A]	HOLDING CURRENT [A]	HOLDING POWER [W]	REPLACEMENT COIL
D24K7	24 VDC	±10%	12	2	2	48	M1903621
D12K7	12 VDC	±10%	3	4	4	48	M1903620



► **ELECTRICAL:**

**STANDARD TERMINAL BOX CODE "B"**

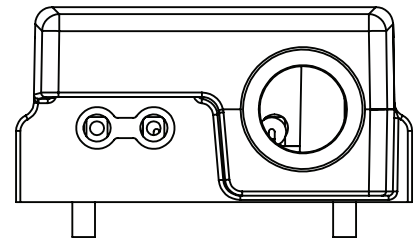
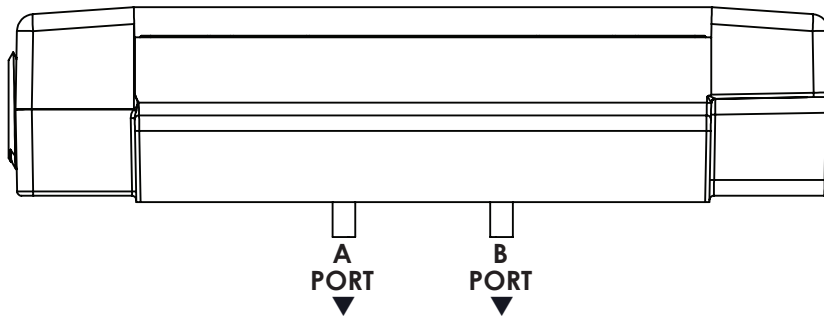
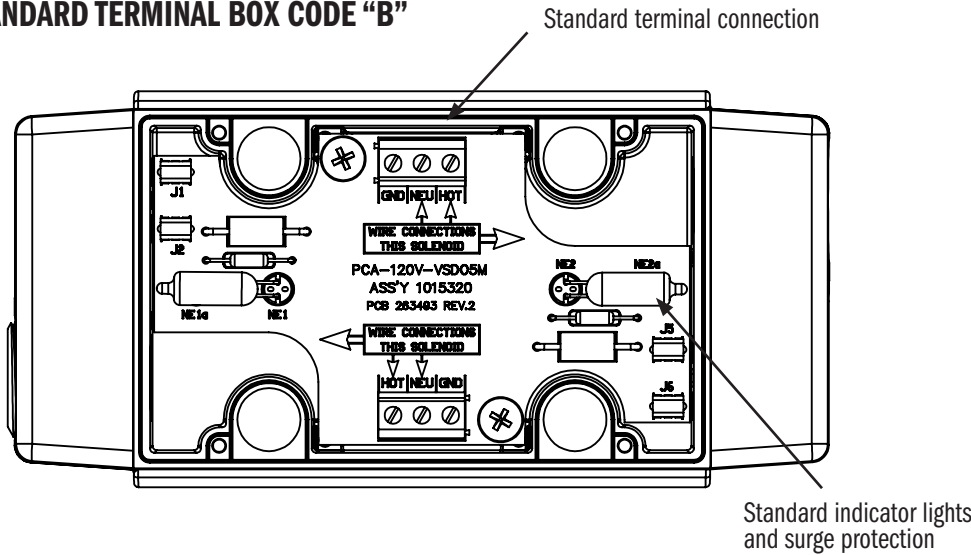

**WASHDOWN OPTION (CODE WD)**

The wash-down option with the electrical box is designed for an IP65 rating. This option uses a special cover without the mounting bolt access holes and uses silicone sealant to help seal between the coil and core tube.

The DIN, Deutsch coils versions of the wash-down option uses silicone sealant to help seal between the coil and core tube.

► **ELECTRICAL OPTIONS:**

**TERMINAL BOX CONNECTION**

**CODE: B5H**

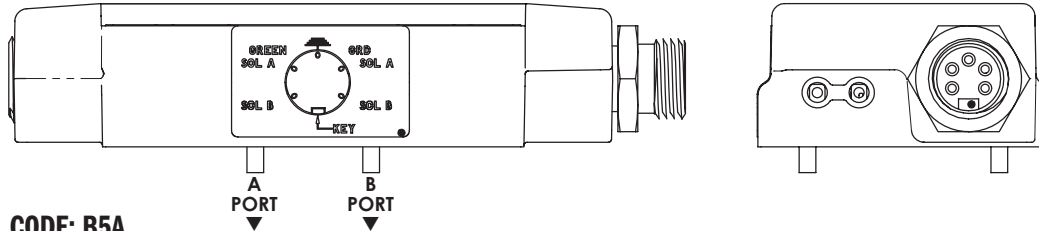

**5 PIN RECEPTACLE**

Male mini receptacles conform to NFPA/T3.5.29 R1 - 2007 used with single or double solenoid valve.

26 mm [1"] Wrench

1	Lead to Solenoid B
2	Lead to Solenoid A
3	Ground Lead (Green)
4	Lead to Solenoid A
5	Lead to Solenoid B

**CODE: B5A**

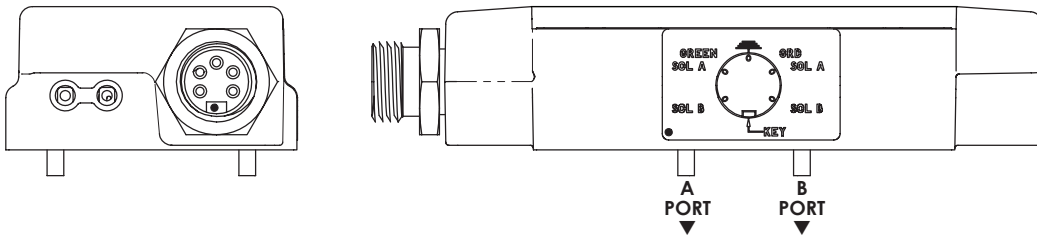

**CODE: B3H**

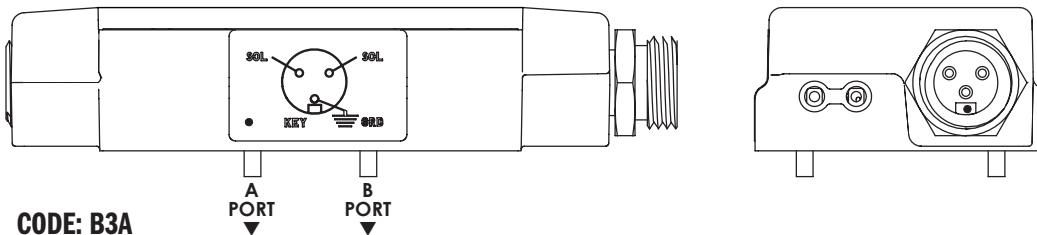

**3 PIN RECEPTACLE**

Male mini receptacles conform to NFPA/T3.5.29 R1 - 2007 used with single solenoid valve.

26 mm [1"] Wrench

1	Ground Lead (Green)
2	Lead to Solenoid
3	Lead to Solenoid

**CODE: B3A**

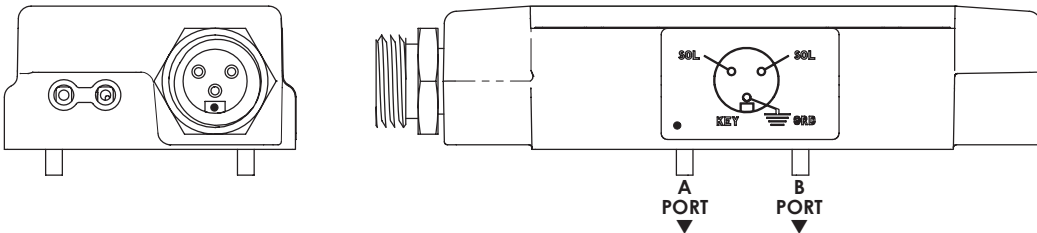

**► ELECTRICAL:**

Dimensions mm [in]

**CONNECTIONS**

See Connectors and Cable Sets Catalog (1027453) for all available connection styles.

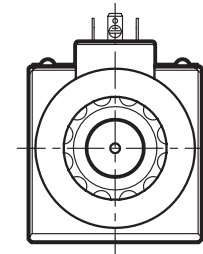
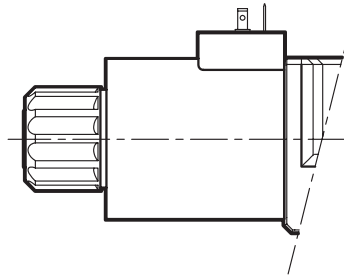
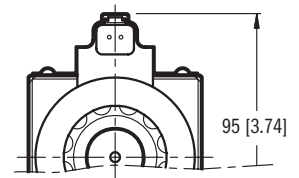
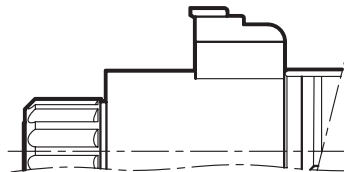
 Connection for  
 EN 175301-803 (ex DIN 43650)  
 connector type code 33, 34, 42, 44

 Connection for  
 DEUTSCH DT06-2S male  
 connector type code D12K7, D24K7

**► APPLICATION DATA:**
**Protection from atmospheric agents IEC 60529**

 All pressure drops shown on these data pages are based on 170 SUS fluid viscosity and 0.87 specific gravity. For any other specific gravity (G1) the pressure drop ( $\Delta P$ ) will be approx.  $\Delta P_1 = \Delta P (G1/G)$ . See the chart for other viscosities.

<b>Fluid</b>	Cst	10	14.5	32	36	43	54	65	76	86	108	216	324	400
<b>Viscosities</b>	SUS	60	75	150	170	200	250	300	350	400	500	1000	1500	1900
<b>Multiplier</b>		0.77	0.81	0.97	1.00	1.04	1.10	1.15	1.20	1.24	1.31	1.56	1.72	1.83

Use mineral oil-based hydraulic fluids HL or HM type, according to ISO 6743-4. For these fluids, use NBR seals. For fluids HFDR type (phosphate esters) use FPM seals (code G). For the use of other kinds of fluid such as HFA, HFB, HFC, please consult our technical department.

Using fluids at temperatures higher than 180°F causes the accelerated degradation of seals as well as degradation of the fluids physical and chemical properties. From a safety standpoint, temperatures above 130° F are not recommended.

<b>Temperature Ranges</b>	Ambient	-4 to +130°F	-20 to +54°F
<b>Fluid Temperature Range</b>	Standard	-4 to +180°F	-20 to +82°F
<b>Fluid Viscosity</b>	Range	60-1900 SUS	10-400 cSt
	Recommended	120 SUS	25 cSt
<b>Fluid Contamination Degree</b>		ISO 4406:1999 Class 20/18/15	

### ► INSTALLATION DATA:

Dimensions inch [mm]

#### INSTALLATION

Valves with centering and return springs can be mounted in any position without impairing correct operation. Valves with mechanical detent should have horizontal mounting.

Valves are fixed by means of screws or tie rods on a flat surface with planarity and roughness equal to or better than those indicated in the relative symbols. If minimum values are not observed, fluid can easily leak between the valve and support surface.

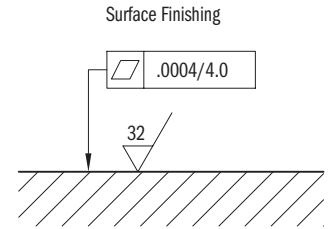

#### SEAL KIT

BUNA SEAL KIT	1015300
VITON SEAL KIT	1015301

#### BOLT KIT

BD05-175	131110
----------	--------

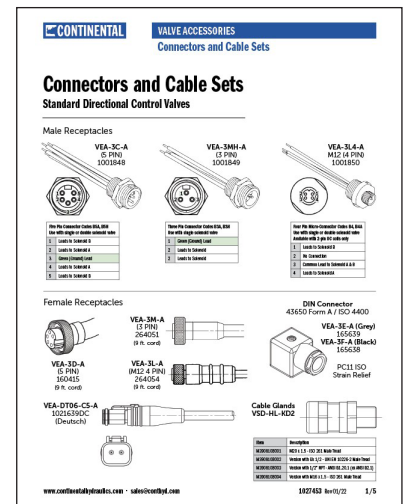

CONTINENTAL HYDRAULICS INC. / HYDRECO INC.

4895 12th Avenue East, Shakopee, Minnesota 55379

952.895.6400 • sales@conthyd.com • [www.continentalhydraulics.com](http://www.continentalhydraulics.com)

704.295.7575 • sales-us@hydreco.com • [www.hydreco.com](http://www.hydreco.com)

© 2024 CONTINENTAL HYDRAULICS Inc., All Rights Reserved. Product specifications and appearance are subject to change without notice.

[www.continentalhydraulics.com](http://www.continentalhydraulics.com) • [sales@conthyd.com](mailto:sales@conthyd.com)

Connectors and Cable Sets

Form #1027453