

VEP03MSV-PDRP

Proportional Three-Port Pressure Reducing Valve Pilot Operated

MODULAR VERSION
ISO 4401-03

P max **4600 PSI 320 bar**
Q max **SEE PERFORMANCE TABLE**

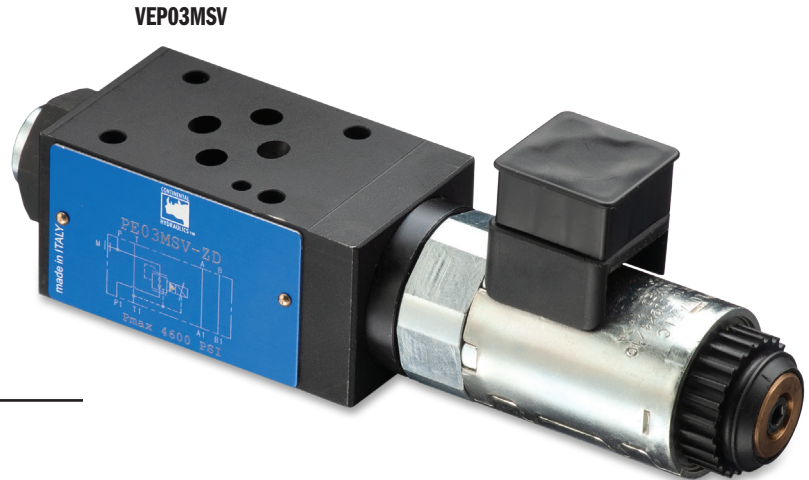

DESCRIPTION

The VEP03MSV-PDRP is a D03 modular three-way proportional pressure reducing/relieving valve which conforms to NFPA D03 and ISO 4401 mounting standards.

These valves are designed to provide remote variable pressure control in the pressure port of a secondary circuit. The controlled pressure is proportional to the amount of current supplied to the solenoid.

As flow demands change, the valve opening will modulate to maintain the circuit pressure. The VEP03MSV-PDRP will also relieve the tank to vent a load induced pressure spike. In event of a loss in electrical power, the valve spool will return to the low-pressure condition.

The proportional solenoids can be driven by a variable current power supply or by use of external Power Amplifier Cards designed to maximize the valve's performance.

Key Features:

- Three Controlled Pressure Ranges up to 3300 PSI outlet.
- D03 Modular stack design for ease of installation
- Rated for flows to 8 GPM

PERFORMANCE (Obtained with mineral oil with viscosity of 36 cSt at 50°C and electronic control card)

Max operating pressure: P - A - B ports T port	PSI (bar)	4600 (320) 30 (2)
Minimum controlled pressure	see Δp-Q diagram page 3	
Maximum flow in P line	GPM (l/mi)	8 (40)
Maximum flow on free flow paths		11 (50)
Drain flow		.09 (0,4)
Step response	see page 2	
Hysteresis (with PWM 200 Hz)	% of p nom	< 3%
Repeatability	% of p nom	< ±1,5%
Electrical characteristics	see page 2	
Ambient temperature range	°F (°C)	-4 / 140 (-20 / +60)
Fluid temperature range	°F (°C)	-4 / 176 (-20 / +80)
Fluid viscosity range	cSt	10 - 400
Fluid contamination degree	according to ISO 4406:1999 class 18/16/13	
Recommended viscosity	cSt	25
Mass	lbs (kg)	3.3 (1.5)

VEP03MSV

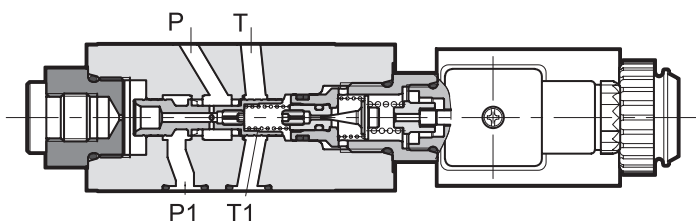

HYDRAULIC SYMBOLS

VEP03MSV-PDRP

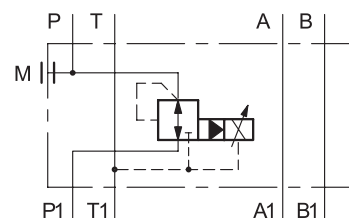

OPERATING PRINCIPLE

- VEP03MSV valves are three-port pressure reducing valves, pilot operated, with proportional control. They are designed in modular version with mounting interface in compliance with ISO 4401-03 standards.
- These valves reduce pressure in the secondary branches of the circuit thus ensuring stability of controlled pressure in the event of variations in the flow rate through the valve.
- The valve can be controlled directly by a current control supply unit or by an electronic control card, to maximize the valve performance.

MAX PRESSURE VALVES

This valve incorporates a mechanical limit of the maximum pressure, that operates independently of the applied current. This kind of design ensures that the pressure cannot rise over even if the solenoid current exceeds the maximum current ($I > I_{max}$).

Values obtained with oil viscosity of 36 cSt at 50 °C and working lines closed (without flow).

VEP03MSV		-070	-150	-230
Pressure value at 780 mA	PSI (bar)	1080 (75)	2250 (155)	3480 (240)
Max pressure value when $I > I_{max}$	PSI (bar)	1375 (95)	2680 (185)	3770 (260)

HYDRAULIC FLUIDS

Use mineral oil-based hydraulic fluids HL or HM type, according to ISO 6743-4. For these fluids, use NBR seals.

For fluids HFDR type (phosphate esters) use FPM seals (code G).

For the use of other fluid types such as HFA, HFB, HFC, please consult our technical department.

Using fluids at temperatures higher than 80 °C causes a faster degradation of the fluid and of the seals characteristics.

The fluid must be preserved in its physical and chemical characteristics.

ELECTRICAL CHARACTERISTICS

Proportional solenoid comprises two parts: tube and coil.

The tube, screwed to the valve body, contains the armature which is designed to maintain friction to a minimum thereby reducing hysteresis.

The coil is mounted on the tube and is secured by means of a lock nut. It can be rotated through 360° depending on installation clearances.

NOMINAL VOLTAGE	V DC	12	24
RESISTANCE (at 20 °C)	Ω	4.98	21
NOMINAL CURRENT	A	1.53	0.78
DUTY CYCLE		100%	
ELECTROMAGNETIC COMPATIBILITY (EMC)	According to 2014/30/EU		
CLASS OF PROTECTION	Class H Class F		
Coil insulation (VDE 0580) Impregnation			

Protection from atmospheric agents IEC 60529

The IP protection degree is guaranteed only with both valve and connectors of an equivalent IP degree correctly connected and installed.

Electric Connection	Electric Connection Protection	Whole Valve Protection
K1	IP65	IP65

STEP RESPONSE

(Obtained with mineral oil with viscosity of 36 cSt at 50 °C and electronic control card)

Step response is the time taken for the valve to reach 90% of the set pressure value following a step change of reference signal. 0 → 100%

The table illustrates typical step response times measured with input flow rate of $Q = 25$ l/min.

REFERENCE SIGNAL STEP	0 → 100%	100 → 0%
Step response [ms]	60	60

IDENTIFICATION CODE:

VEP03MSV - PDRP - [] - [] - K1 [] D - [] ————— DESIGN LETTER

CONTROL ON 'P' PORT

PRESSURE RANGE

CODE	PSI	BAR
70	72 to 1060	5 to 70
150	80 to 2450	5.5 to 150
230	90 to 3300	6 to 230

SEAL MATERIAL

CODE	DESCRIPTION
A	BUNA (STD)
G	VITON

CONNECTION

CODE	DESCRIPTION
K1	DIN 43650

VOLTAGE

CODE	DESCRIPTION
12	12V DC
24	24V DC

TYPICAL ORDERING CODE:
VEP03MSV-PDRP-230-A-K124D-A

CHARACTERISTIC CURVES (Measured with viscosity 36 cSt at 50 °C)

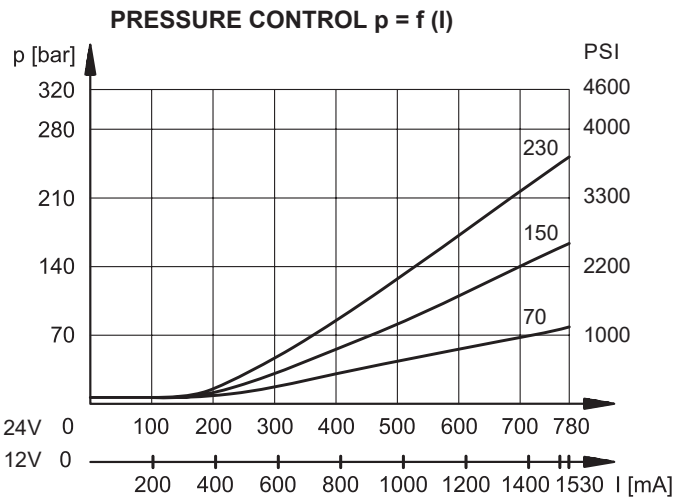

The curves have been obtained with working lines closed (without flow).

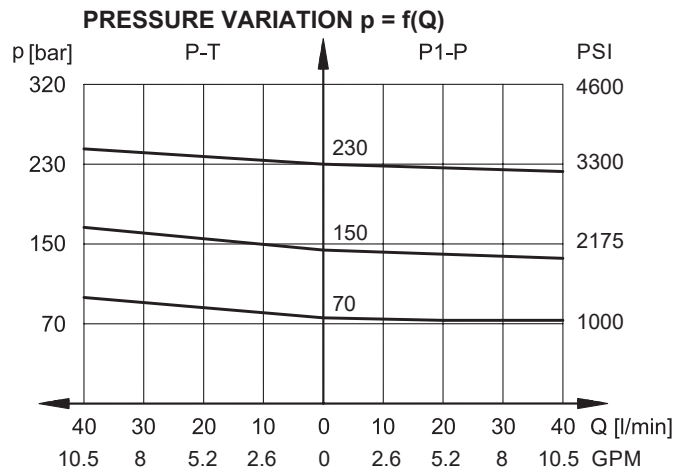

The curves have been obtained with inlet pressure 50 bar greater than nominal pressure.

Pressure values in P1 greater than 50 bar reduce flow values considerably.

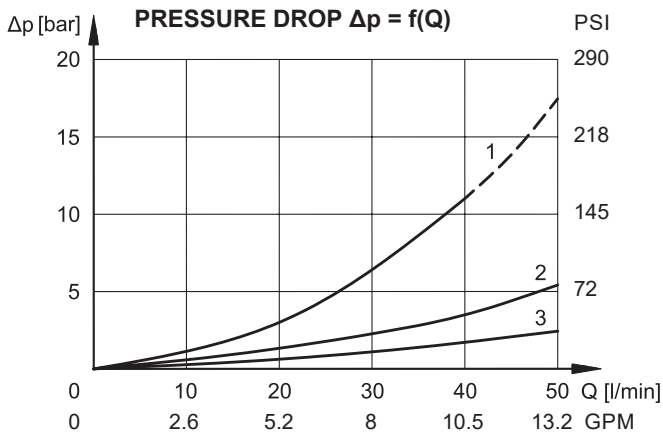

1. Pressure drops P1 → P
2. Pressure drop in passing lines (ex. A ↔ A1)
3. Pressure drops T 1 → T

OVERALL AND MOUNTING DIMENSIONS Dimensions inch [mm]

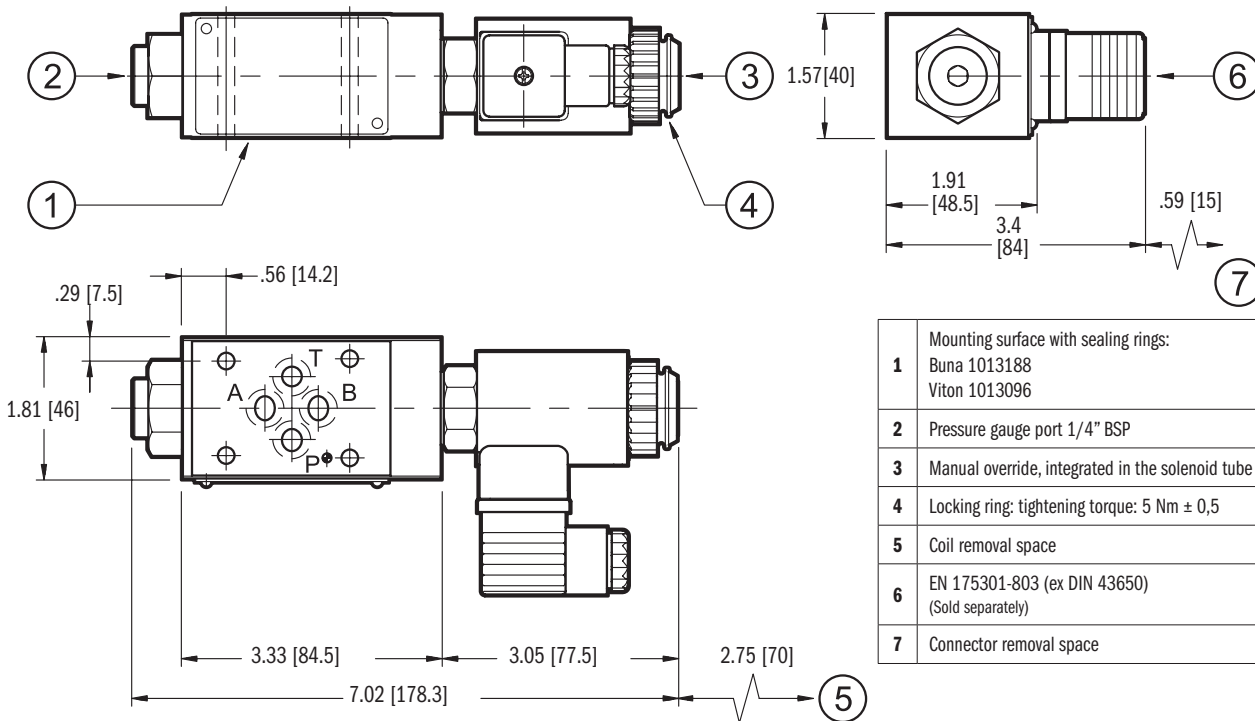

INSTALLATION

These valves can be installed in any position without impairing correct operation if it is ensured that there is no air in the hydraulic circuit. Otherwise, vertical mounting with solenoid downward is preferable. In this case you must consider possible variations of the minimum controlled pressure values reported in point 2. Connect the valve T port directly to the reservoir.

Add any return pressure value detected in the T line to the reduced pressure value.

NOTE: Occurring return pressures are to be added up to the value of pressure setting at T port.

Valves are fixed by means of screws or tie rods on a flat surface with planarity and roughness equal to or better than those indicated in the relative symbols. If minimum values are not observed fluid can easily leak between the valve and support surface.

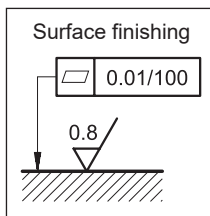

MOUNTING INTERFACE

Dimensions inch [mm]

NFPA D03
ISO 4401-03-02-0-03
(CETOP 4.2-4-03-320)

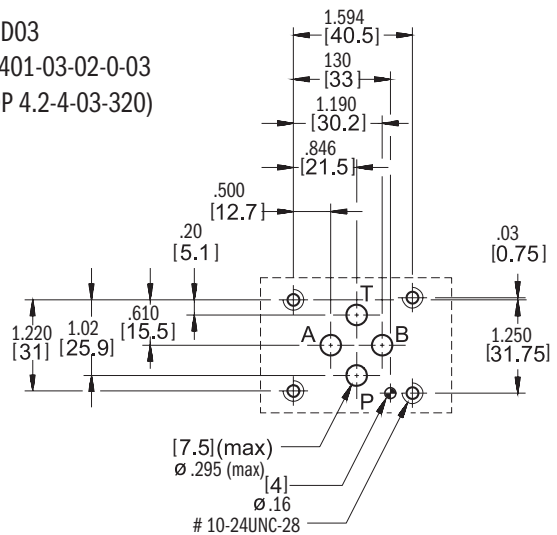



PROUD MEMBER OF THE  GROUP

CONTINENTAL HYDRAULICS INC. / HYDRECO INC.

4895 12th Avenue East, Shakopee, Minnesota 55379

952.895.6400 • sales@conthyd.com • www.continentalhydraulics.com

704.295.7575 • sales-us@hydreco.com • www.hydreco.com

© 2022 CONTINENTAL HYDRAULICS Inc., All Rights Reserved. Product specifications and appearance are subject to change without notice.