



REPAIR PROCEDURES MANUAL

PVX Series Vane Pumps "A" Design Series



Step-by-Step Guide to Troubleshooting and Repairing PVX Series Vane Pumps

Introduction

Thank you for choosing Continental Hydraulics PVX Vane Pumps for your application.

PVX Pumps are designed to provide reliable performance, and to be easily repaired should the need arise. The procedures in this repair manual will show you how to repair virtually any part of your pump.

To assure that your repaired PVX Pump performs reliably, please follow all steps carefully. It is also very important that your work area be kept clean to prevent introducing contaminants into the pump.

In many cases, dirt or contaminants in the hydraulic system lead to pump wear and failure. If your PVX pump failed due to dirt or contamination, be sure to thoroughly clean and flush all parts of the system, paying special attention to power unit reservoirs. You may want to provide additional filtering to keep your pumps and system operating at peak performance.



NOTE: All procedures in this manual are to be performed on a service bench. Do not disassemble, or attempt to repair a pump that is connected to a hydraulic system.



CAUTION – Before attempting to remove the PVX Vane Pump, be sure that all pressure has been relieved from BOTH SIDES of the system.



CAUTION – Before attempting to remove the PVX Vane Pump, disconnect or lock off power supply.



CAUTION – Before manually actuating any PVX Vane Pump, be sure that any resulting machine function will not endanger persons or equipment.

PRODUCT IDENTIFICATION

Each PVX Vane Pump has a Model Code stamped on its nameplate. See Figure 1 for the location of the Model Code.

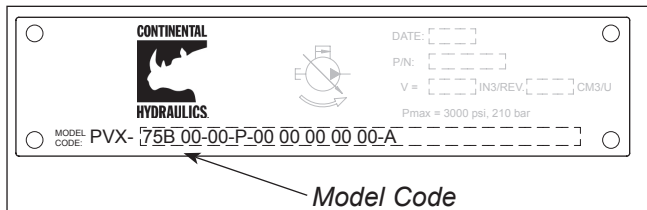

Figure 1

This Repair Manual applies to products with Ordering Codes like the sample in Figure 2.

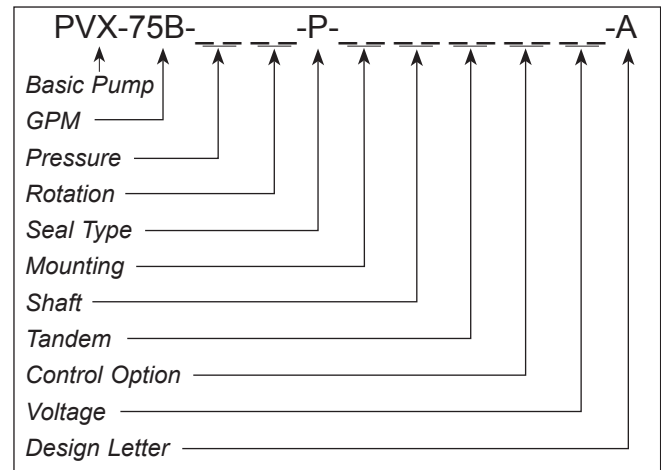

Figure 2

Table of Contents

Part Identification		Adjustment Procedure – Single Stage Compensator	
Exploded View Drawing	2	General	23-24
Parts List	2		
Disassembly Procedures – Pumps		Adjustment Procedure – Two-Stage Compensator	
General.....	3	General	25
Getting Started	3		
Disassembly Instructions	3-6	Multi-Pressure Compensator	
Assembly Procedures – Pumps		General Information	26
General	7	Solenoid Two-Pressure Control	26
Getting Started - Kits	7	Solenoid Vented	27
Getting Started - Tools	8	Load Sense	27-29
Assembly instructions	8-13	Torque Limiter	29-30
		Setting the Maximum Deadhead Pressure (Second Stage Setting)	31
Disassembly Procedure – Two-Stage Compensator		Setting the Torque Limiter	31
General	14	Application Notes	31
Disassembly Instructions	14-15	Maximum Flow Limiter	31
		Fluids, Filters and System Preparation	
Assembly Procedure – Two-Stage Compensator		General Information	32
Assembly Instructions	16-18	Fluid Recommendations	32
		Fluid Temperature	32
Disassembly Procedure – Single Stage Compensator		Filtration	32
General	19	Pump Installation Procedure	
Disassembly Instructions	19	Installation Instructions	33
		System Start-Up Procedure	
Assembly Procedure – Single Stage Compensator		Start-Up Instructions	34
General	20	Trouble Shooting	
Getting Started - Kits	20	Trouble, Potential Cause, Remedy	35-37
Assembly Instructions	20-21		
		Dimensions for Double Pumps	
Proper Setting of the Thrust Screw		Dimension Drawing	38
Adjustment Instructions	22	Possible Size Combinations	38

Part Identification

Exploded View Drawing

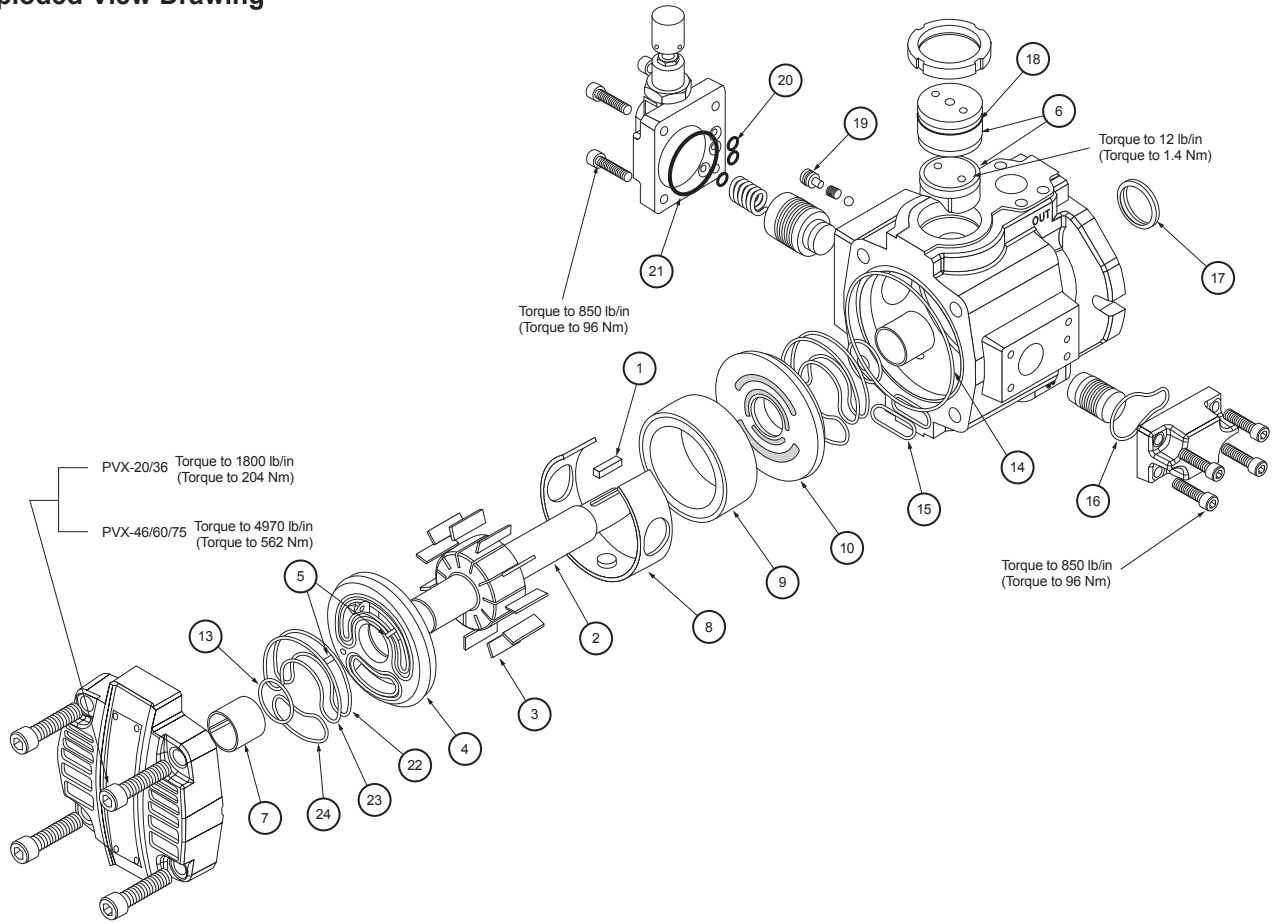

Parts List

REFERENCE	DESCRIPTION	QTY			
1	Key	1	15	O-ring, ASA-130 / (ASA-229)	1
2	Rotor shaft	1	16	O-ring, ASA-146 / (ASA-146)	1
3	Vane kit	1	17	Shaft seal	1
4	Port plate, cover side	1	18	O-ring, ASA-332 / (ASA-340)	1
5	Roll pin	4	19	O-ring, ASA-110 / (ASA-110)	1
6	Thrust block	1	20	O-ring, ASA-111 / (ASA-111)	3
7	Bearing	2	21	O-ring, ASA-143 / (ASA-143)	1
8	Spacer ring	1	22	O-ring, ASA-157 / (ASA-160)	2
9	Pressure ring	1	23	Back up ring	2
10	Port plate, body side	1	24	O-ring, ASA-139 / (ASA-152)	1
13	O-ring, ASA-031 / (ASA-035)	2	24	O-ring, ASA-237 / (ASA-237)	1
14	O-ring, ASA-162 / (ASA-265)	1			
REFERENCE	DESCRIPTION	QTY			

Disassembly Procedures – Pumps

General

The disassembly procedure shown on the following pages covers the Continental Hydraulics PVX-8 thru 75 variable volume vane pumps. The complete disassembly procedures are similar for all pumps. Any differences between the pump models are described in additional notes.

The step number corresponds to the photo or illustration of the same number.
Any dimensions or values stated will have the English value first followed by the metric equivalent in parenthesis.

Getting Started - Tools

PVX Model	8	11/15	20/29/36	46/60/75
Cover				
Allen Wrench	8 mm	10 mm	14 mm	17mm
4 Soc. Cap Screws				
Cover - Removal	2 Flat Blade Screwdrivers			
Plates - Removal	Tweezers or Pair of Long Needle Nose Pliers			
Vanes - Removal	11 Vanes 22 Vanes			
Compensator & Bias Cover	6 mm		8 mm	
Allen Wrench				
2 x 4 Soc. Cap Screws	PVX-8/11/15 - 8 mm Allen Wrench PVX-20/29/36/46/60/75 - Non-Slip Spanner Wrench			
Thrust Screw	Adjustable Face Spanner Wrench			
Thrust Screw Lock Nut	Blind Hole Bearing Puller			
Bearing - Removal	Hammer & Round Head Punch			
Shaft Seal - Removal				

As an aid for repairing the PVX pump, we recommend building a wooden fixture. Please see the different inside diameters for each pump size in the chart below.

PVX Model	8	11/15	20/29/36	46/60/75
Diameter	3.38 (86)	4.13 (105)	5.13 (131)	6.13 (156)
Min. Height	2 (51)	2.63 (67)	3 (77)	3.88 (99)

Wooden Fixture.

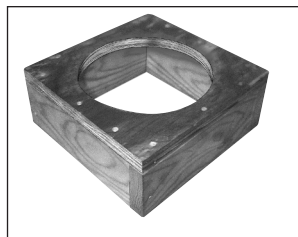

Disassembly Instructions

1. Remove the straight key from the keyway of the shaft and place the pump side down into the wooden fixture. See above for details for the fixture.



Figure 1.

2. Remove the four (4) socket hd cap screws on the cover by using the appropriate size Allen wrench.



Figure 2.

Note: For disassembling the larger pumps, a great amount of torque will be needed to loosen the cover bolts. Therefore, we recommend loosening the bolts before removing the pump from the motor-unit. Use a socket or extend the length of the allen wrench and make sure to clamp the pump securely and safely.



Figure 2a.

Disassembly Instructions – Pumps (continued)

3. Insert flat blade screwdriver into the slots provided on each side of the cover. Pry the cover assembly loose using equal force on each screwdriver. After the cover is loose, carefully remove it by hand and set aside in a clean area.

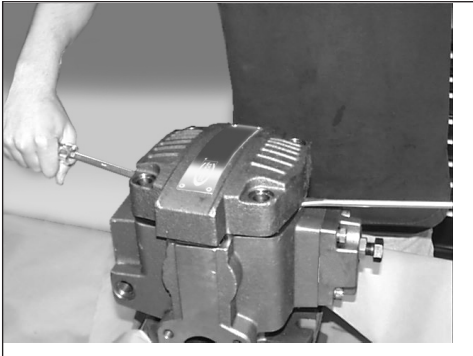

Figure 3.

4. In order to remove the port plate from the cover, insert flat blade screwdriver into the slots between the port plate and cover and pry the port plate loose. After the port plate is loose, carefully remove it by hand.



Figure 4.

NOTE: When disassembling a PVX-20 thru 75 pump, please pay close attention not to loosen the ratio valve cartridge that is located in the cover and the ratio valve sealing assembly that is located on the back of the cover port plate. The ratio valve cartridge is an essential part of the pump and is not a wear item, so it is not part of the repair kit.



Figure 4a.

5. Remove the cover o-ring.



Figure 5.

6. Remove the vanes from the rotor by using a small pair of tweezers or long needle nose pliers. Caution should be taken not to nick or score the vanes, pressure ring and rotor.

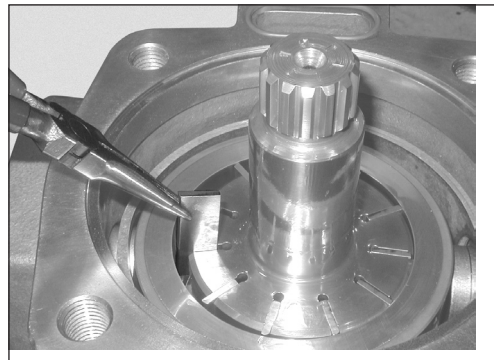

Figure

6.

7. Remove the rotor shaft.



Figure 7.

Disassembly Instructions – Pumps (continued)

8. Remove the four (4) socket head cap screws on the compensator by using the appropriate Allen wrench and remove the compensator.

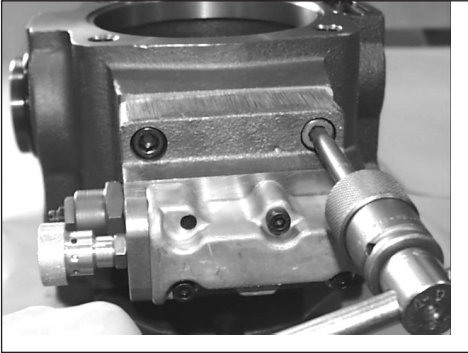

Figure 8.

9. Carefully remove the control piston and spring. Caution should be taken not to nick or scratch the piston or the piston bore.

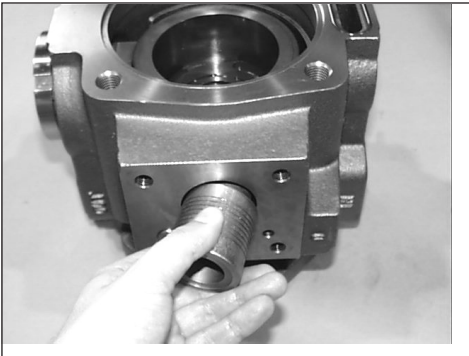

Figure 9.

10. Remove the four (4) socket head cap screws on the bias cover by using the appropriate Allen wrench and remove the bias cover. The bias cover is over the bias piston or the smaller piston opposite the control piston. Carefully remove the bias piston ensuring that the bias piston and the piston bore are not scratched or nicked.

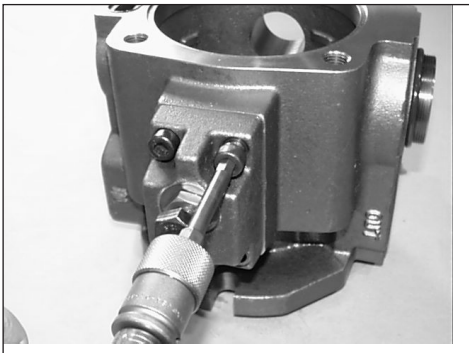

Figure 10.

11. For the PVX-8/11/15 pumps, loosen the locknut with adjustable wrench (not pictured). For the PVX-20 thru 75 pumps, loosen the thrust screw lock ring by using a spanner wrench.

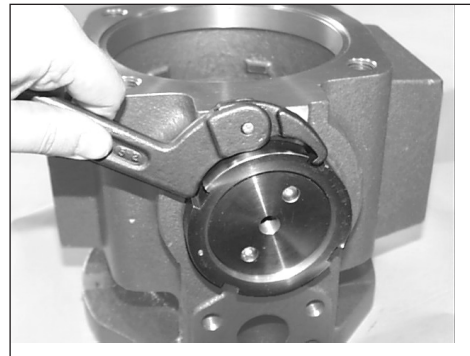

Figure 11.

12. Remove the thrust screw by using the appropriate spanner socket or Allen wrench.



Figure 12.

NOTE: The PVX-20 thru 75 pumps has a thrust block in addition to the thrust screw. Remove the thrust block also.

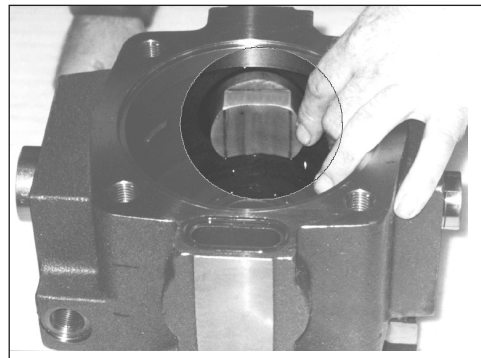

Figure 12a.

Disassembly Instructions – Pumps (continued)

13. Remove the pressure ring.



Figure 13.

14. Remove the spacer ring.



Figure 14.

15. Remove the port plate from the body by carefully grabbing the port plate at the thru-hole location. After the plate has been lifted out, set it aside. Be careful not to scratch or nick the coating on the port plates. Leave the seals in the port plate.

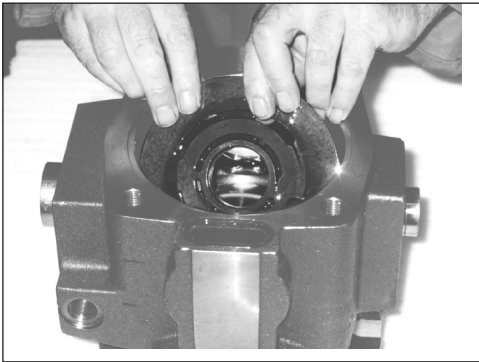

Figure 15.

16. If the bearings are damaged and need to be replaced, remove the bearings in the body and the cover by using a blind hole bearing puller.

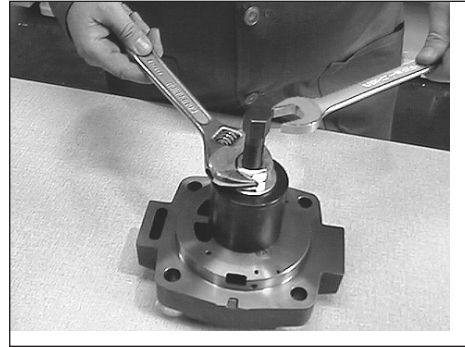

Figure 16.

17. To drive out the shaft seal, take a round head punch and carefully tap out from the cover side of the pump. Remove the shaft seal.

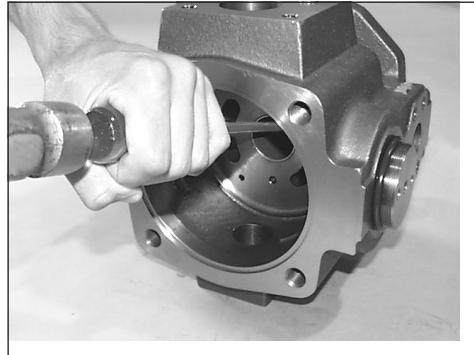

Figure 17.

18. After the pump has been completely disassembled, all parts must be thoroughly cleaned with clean solvent. At this time, inspect and determine which parts need to be replaced. In a major overhaul, it is recommended that both bearings and all seals be replaced regardless of their condition. Kits containing all seals are available for use in the repair of this pump.

When ordering repair parts, it is necessary to provide the alpha-code and appropriate design letter describing the pump. This information can be found on the nameplate attached to the rear cover of the pump body.

Assembly Procedures – Pumps

General

To guarantee proper operation of your PVX pump, Continental Hydraulics recommends relacing all important pump parts by using the CHD Repair Kit and the CHD Seal Kit. The complete assembly procedures are similar for all pumps. Any differences between the pump models are described in additional notes.

The step number corresponds to the photo or illustration of the same number.
Any dimensions or values stated will have the English value first followed by the metric equivalent in parenthesis.

Getting Started - Kits

Repair Kits

MODEL	SAE	SAE - "P1"
PVX-8	264288	264289
PVX-11/15	264292	264293
PVX-20	264296	264297
PVX-29	264296	264297
PVX-36	264300	264301
PVX-46	264304	264305
PVX-60	264304	264305
PVX-75	264308	264309

Repair Kits consists of:

REF	DESCRIPTION	QTY
1	Key	1
2	Rotor Shaft	1
3	Vane Kit	1
4	Port Plate - Cover	1
5	Roll Pin	4
6	Thrust Screw Assembly (PVX-8/11/15)	1
6	Thrust Block Assembly (PVX-20-75)	1
7	Bearing	2
8	Spacer Ring	1
9	Pressure Ring	1
10	Port Plate - Body	1

Seal Kits

MODEL	SAE
PVX-8	264275
PVX-11/15	264276
PVX-20/29/36	264277
PVX-46/60/75	264278

Seal Kits consists of:

REF	DESCRIPTION	QTY
13	O-Ring - Root Seal	2
14	O-Ring - Cover	1
15	O-Ring - Secondary Inlet (PVX-20-75)	1
16	O-Ring - Bias Cover	1
17	Shaft Seal	1
18	O-Ring - Thrust Screw	1
19	O-Ring - Check	1
20/21	O-Ring - Compensator * (PVX-20-75)	1
22/24	O-Ring - Port Plate **	2
23	Back-Up Ring - Port Plate	2

* See instructions for Single or Two-Stage Compensators later in this manual.

** Quantities may vary depending on pump model.

Overview Torque Rates

PVX in.-lbs. (Nm)	8	11/15	20/29/36	46/60/75
Cover	700 (82)	1200 (140)	1800 (210)	4970 (580)
Bias Cover	350 (41)	350 (41)	680 (80)	680 (80)
Compensator	350 (41)	350 (41)	680 (80)	680 (80)
Thrust Screw Nut	960 (112)	960 (112)	* See Note	

* NOTE: On PVX-20 thru 75 pumps, tighten the Thrust Screw Locking Ring as tight as possible.

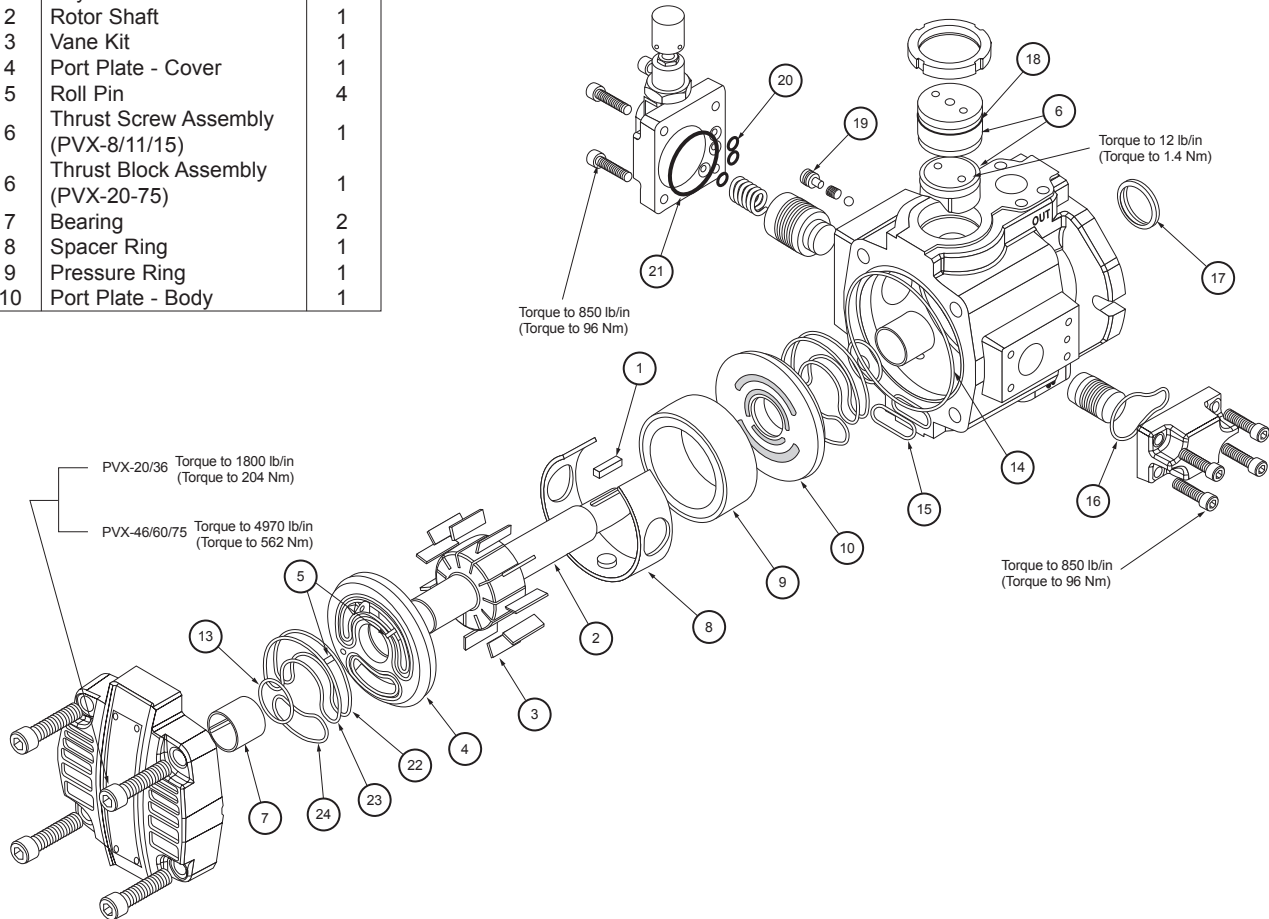

Assembly Procedures – Pumps (continued)

Getting Started - Tools

PVX Model	8	11/15	20/29/36	46/60/75
Cover	8 mm	10 mm	14 mm	17mm
Allen Wrench				
Installation Pins into Port Plates	Hammer			
Compensator & Bias Cover	6 mm		8 mm	
Allen Wrench				
Thrust Screw	Spanner Socket - 8 mm Allen Wrench			
Thrust Screw Lock Nut	Adjustable Face Spanner Wrench			
Bearing and Shaft	Press, Loctite 7070 Cleaner and			
Seal Installation	Loctite 569 Hydraulic Sealant			
Lubrication	Clean Hydraulic Oil			

Assembly Instructions

1. Before installing the shaft seal, clean the seal bore and seal O.D. with Loctite 7070 cleaner and place some hydraulic sealant (Loctite 569) on the O.D. surface of the shaft seal as shown.

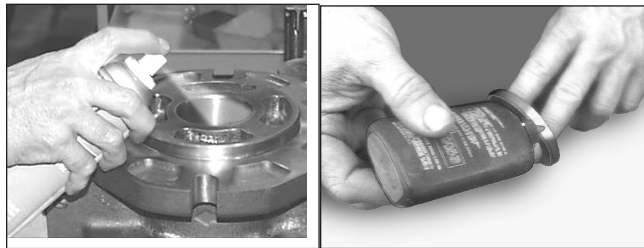

Figure 1.

2. Press the shaft seal into the pump body to the depths (± 0.5 mm tolerance) recommended in the following chart with the depth being measured from the pump housing surface. Insure that the shaft seal is installed properly in the pump body or leakage will occur.

PVX Model	8	11/15	20/29/36	46/60/75
Depth (mm)	2.0 mm	4.3 mm	10.0 mm	



Figure 2.

3. Replace the bearing for the body and cover. The bearings for both are identical. Place the bearings into the bearing bores and thoroughly lubricate the bearing's I.D. with clean hydraulic fluid. **Pay close attention to the correct orientation of the bearing prior to installing the bearings in the pump body and cover as shown.**

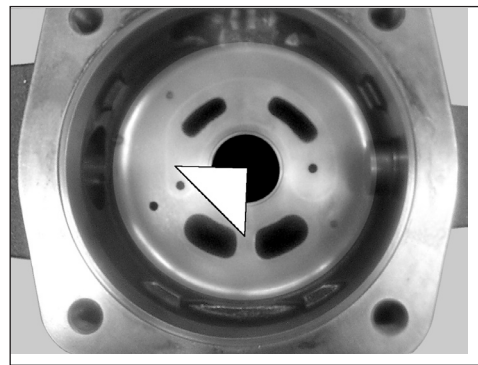

Figure 3.

NOTE: It is recommended that a guide tool be used to properly install the bearings in the bores. After the bearing is installed, make sure the bearing is flush to 0.020" (0.5 mm) below the machined surface. Using a new rotor shaft, check the fit of the shaft to the installed bearings and assure that the shaft enters the bearing without drag. Replace the bearing if any drag is noticed.

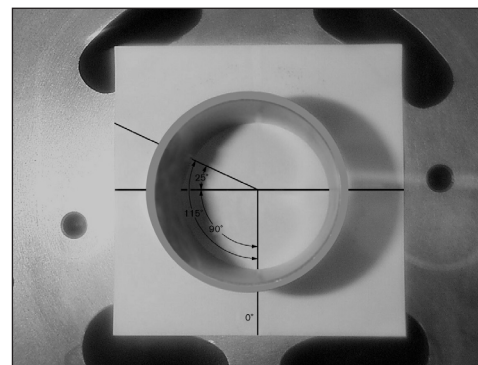

Figure 3a.

4. Drive the roll pins into the holes on the back side of each port plate so they protrude .3" (7.6 mm). Replace the port plates.



Figure 4.

Assembly Procedures – Pumps (continued)

5. Replace the seals and back-up rings on the backside of both port plates. Install seals on each port plate.



Figure 5.

6. If necessary, use a light grease or petroleum jelly to help retain the seals during placement of the port plates into the body. Avoid applying too much grease on the seals during assembly since this condition can cause the O-rings to dislodge when the port plates are installed in the pump.



Figure

6.

Cover Port Plates

Ref.	Description	Quantity	
		8/11/15	20/29/36 46/60/75
15	Back-up Seal (white) in lg. race track	1	1
15	Back-up Seal (white) in sm. c'bore	0	1
18	O-Ring in large race track	1	1
18	O-Ring in small race track	1	1
19	O-Ring in counterbore	1	1
21	O-Ring in small counterbore	0	1

Body Port Plates

Ref.	Description	Quantity	
		811/15	20/29/36 46/60/75
15	Back-up Seal (white) in lg. race track	1	1
18	O-Ring in large race track	1	1
18	O-Ring in small race track	1	1
19	O-Ring in counterbore	1	1

7. Place the port plate into the body. Note that the pins fit in the provided holes. Completely lubricate the port plate's wear surface with clean hydraulic fluid.

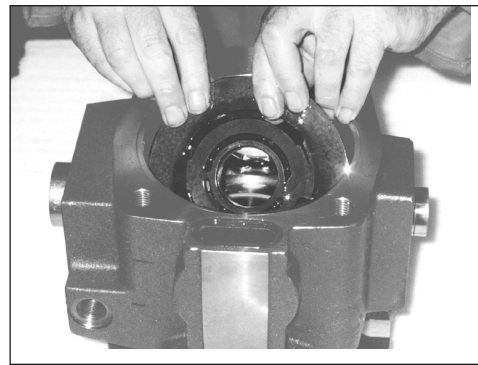

Figure 7.

NOTE: Be certain to ensure that the correct port plates are installed in the body and cover. If unsure, compare the arrows on the port plates with the arrow on the pump. The arrow on the pump can be found below the open segment for the control piston on the pump body. Both arrows must point in the same direction. All PVX pumps operate in a clockwise only direction of rotation as viewed from the shaft end of the pump.

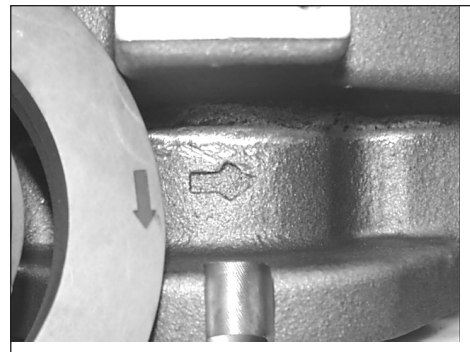

Figure 7a.

8. Install the spacer ring in the pump body.

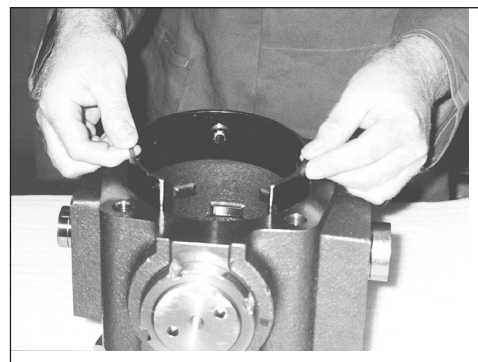

Figure 8.

NOTE: On the PVX-8/11/15 pumps, there is no break in the spacer ring. Align the break with the thrust screw. On the PVX-20 thru 75 pumps, the open segment on the spacer ring aligns with the thrust block bore.

Assembly Procedures – Pumps (continued)

9. Assemble the bias piston into the body through the clearance hole in the spacer ring. Lubricate the piston with clean hydraulic fluid.

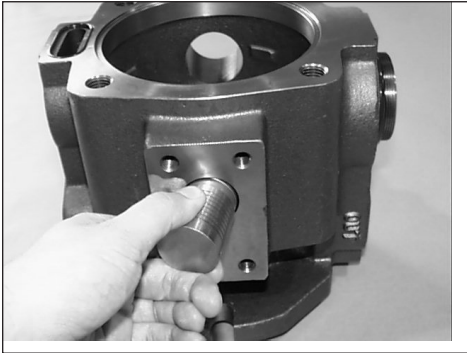

Figure 9.

10. Assemble the control piston and spring through the clearance hole in the spacer ring. Lubricate the piston before installing.

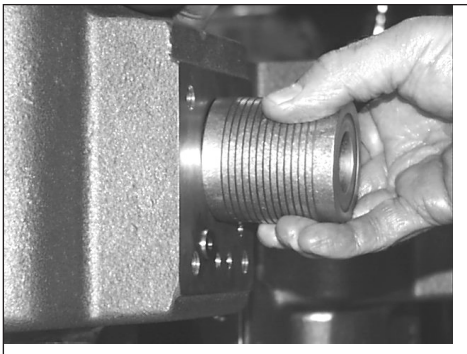

Figure 10.

11. Thoroughly lubricate the pressure ring with clean hydraulic fluid. Place the pressure ring in the pump body.



Figure 11.

12. For PVX-8/11/15 pumps, install the thrust screw in the body by using an Allen head wrench. For PVX-20 thru 75 pumps, prior to installing the thrust screw assembly, lightly coat the bearing surface on the thrust block assembly with clean hydraulic fluid.



Figure 12.

12a. For PVX-20 thru 75 pumps, install the thrust screw with O-ring by using a spanner wrench and socket. Install the thrust block with plastic pad in the body. The contoured end has to align with the pressure ring.

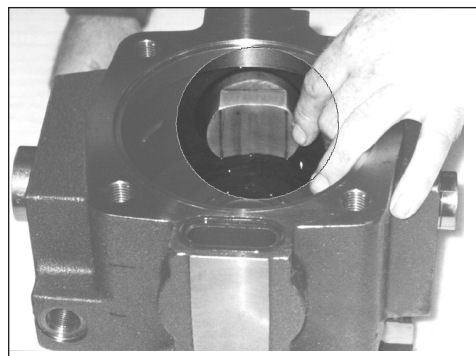

Figure 12a.

For preliminary adjustment of the thrust screw, tighten it all the way and then turn out a 3/4 turn counterclockwise. Take care not to over-tighten the thrust screw as damage to the pump can occur. See the section "Proper Setting of the Thrust Screw" later in this manual for further adjustments.

Assembly Procedures – Pumps (continued)

13. For PVX-8/11/15 pumps, use an Allen wrench to tighten the thrust screw to the torque rates shown. For PVX-20 thru 75 pumps, install the thrust screw lock ring and tighten it by using the adjustable face spanner wrench.

Torque Rates in.-lbs. (Nm)

PVX Model	8/11/15	20/29/36/46/60/75
Thrust Screw	960 (112)	Tighten with Spanner Wrench

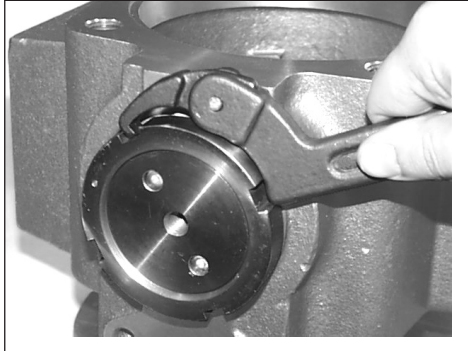

Figure 13.

14. Prior to replacing the rotor shaft, lubricate it with clean hydraulic fluid. Replace the rotor shaft. Care must be taken not to damage the shaft seal while inserting the shaft.

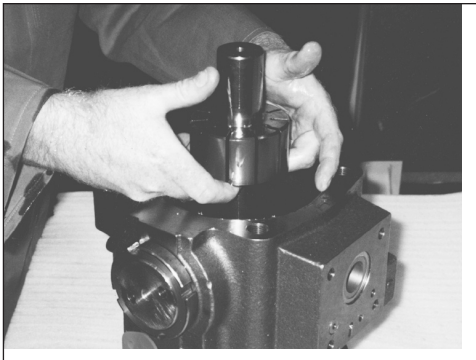

Figure 14.

15. Lubricate the vanes with clean hydraulic fluid and place the vanes in the rotor vane slots. The rounded tips of the vanes must contact the I.D. of the pressure ring.

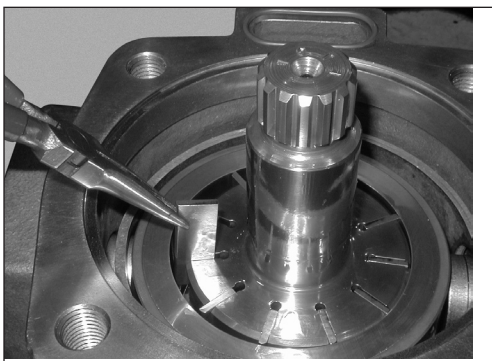

Figure 15.

15a. Make sure that the direction of the rounded vane tips matches the direction of pump rotation. The pump rotation is shown on the pump body and the port plates. Make sure the vanes slide freely in the rotor vane slots.

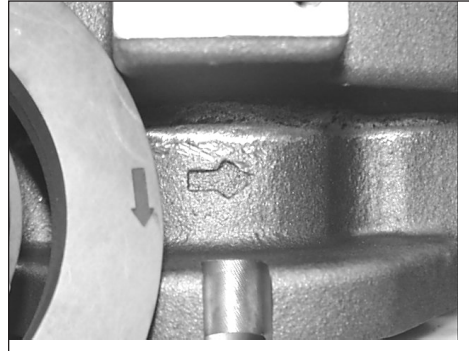

Figure 15a.

16. Prior to mounting the compensator to the pump body, install all o-rings on the mating surface of the compensator's first stage. A minimum amount of grease or petroleum jelly may be used to retain the o-rings during placement. Keep the mating interface of the compensator and the pump housing free of grease.

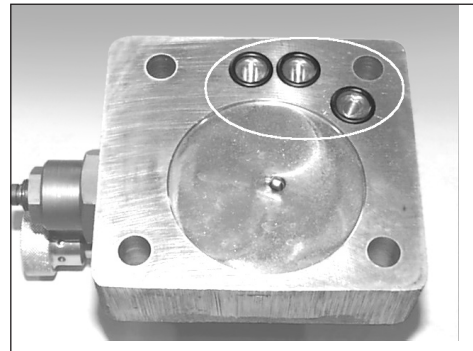

Figure 16.

Figure 17.

Assembly Procedures – Pumps (continued)

17. Mount the compensator to the pump and torque the four (4) socket head cap screws by using the appropriate Allen wrench.

Torque Rates in.-lbs. (Nm)

PVX Model	8/11/15	20/29/36/46/60/75
Compensator	350 (41)	680 (80)

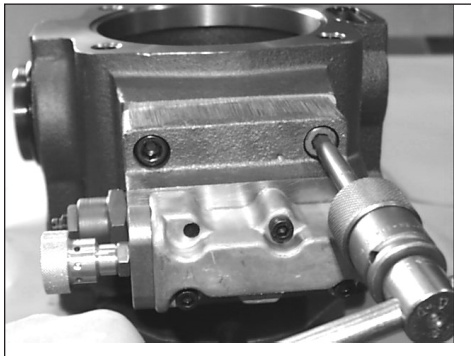

Figure 17.

18. Install the O-ring on the mating surface of the bias cap/volume control. A minimum amount of grease or petroleum jelly may be used to retain the O-ring in its groove. Torque the four (4) socket head cap screws by using the appropriate Allen wrench.

Torque Rates in.-lbs. (Nm)

PVX Model	8/11/15	20/29/36/46/60/75
Bias Cover	350 (41)	680 (80)

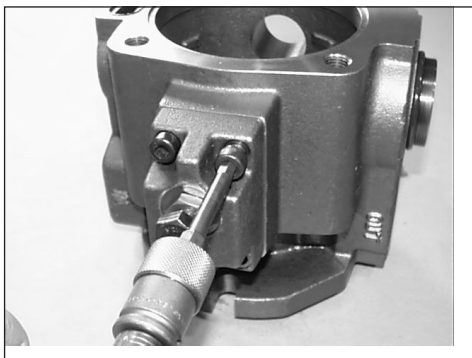

Figure 18.

19. Insert O-ring onto the body pilot bore. A minimum amount of grease or petroleum jelly may be used to hold the O-ring in place while installing the cover.



Figure 19.

19a. For PVX-20 thru 75 pumps, insert a second O-ring into the secondary inlet.

Assemble the port plate on to the cover. Assure that the orientation of the port plate is correct on the PVX-20 thru 75 pumps, such that the secondary inlet passages in the cover line up with the small O-ring in the back of the cover port plate.



Figure 19a.

Assembly Procedures – Pumps (continued)

20. Install the cover by inserting the four (4) socket head cap screws with the appropriate Allen wrench or socket. Torque the screws from the chart below. Keep the mating surfaces of the pump body and cover free of oil, dirt and/or grease before assembling the cover.



Figure 20.

21. Insert the straight key into the keyway of the shaft.

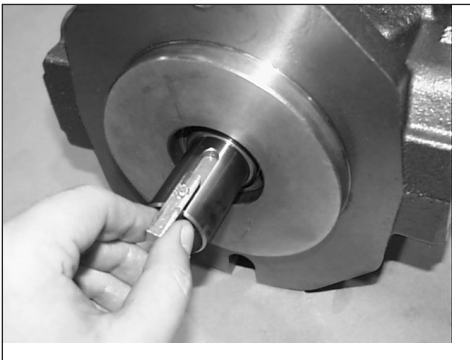

Figure 21.

Disassembly Procedures – Two-Stage Compensator

General

Shown below are the Continental Hydraulics two-stage compensators rated at 3000 psi (210 bar). On the left is for PVX-8/11/15; on the right, PVX-20 thru 75. Following that are the complete disassembly procedures. Any differences between the compensator models are described in additional notes.

The step number corresponds to the photo or illustration of the same number.
Any dimensions or values stated will have the English value first followed by the metric equivalent in parenthesis.

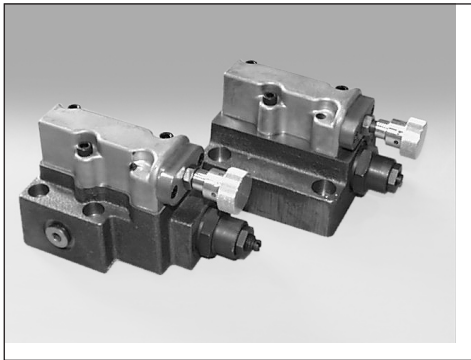

Left: PVX-8/11/15; Right: PVX-20 thru 75

Disassembly Instructions

1. Remove the two (2) socket head cap screws attaching the pressure adjustment cap to the body of the second stage by using the appropriate wrench. Remove the pressure adjustment cap and the adjusting screw as one assembly.

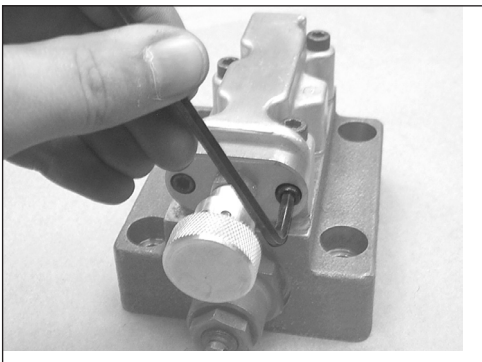

Figure 1.

2. Remove the spring and the seat from the second stage body.

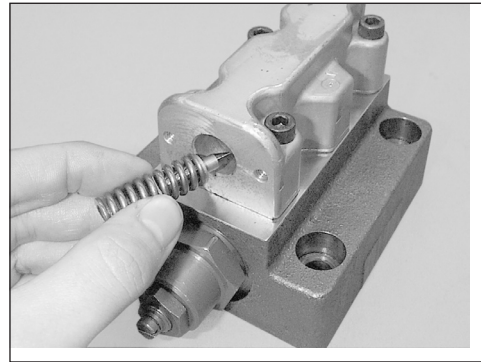
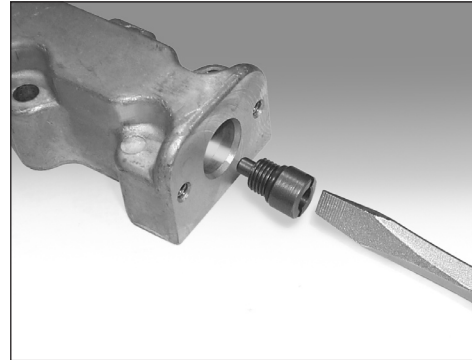

Figure 2.

3. In order to remove the guided poppet, take a large flat blade screwdriver and unscrew the guided poppet from the second stage of the compensator.



Figure

3.

4. Remove the plug from the second stage by using the appropriate Allen wrench.

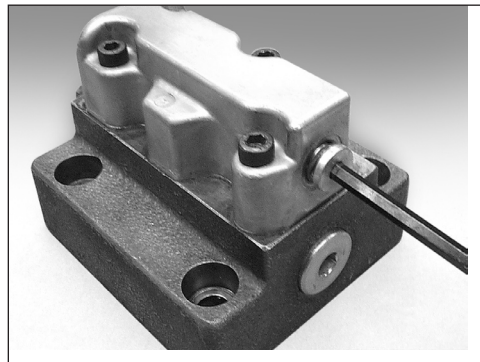

Figure

4.

Disassembly Procedures – Two-Stage Compensator (continued)

5. Remove the three (3) socket head cap screws that attach the second stage to the first stage body by using the appropriate Allen wrench.

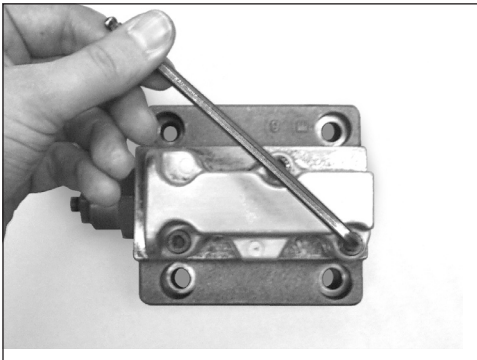

Figure 5.

6. Remove the plug from the first stage compensator by using the appropriate Allen wrench.

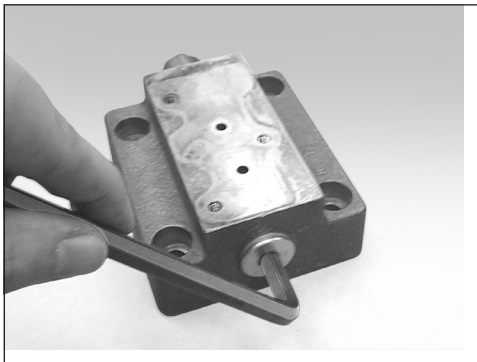

Figure 6.

6a. The two-stage compensator for the PVX-8/11/15 pumps has a shock clipper which is located on the side of the first stage body. Remove the plug by using the appropriate Allen wrench.

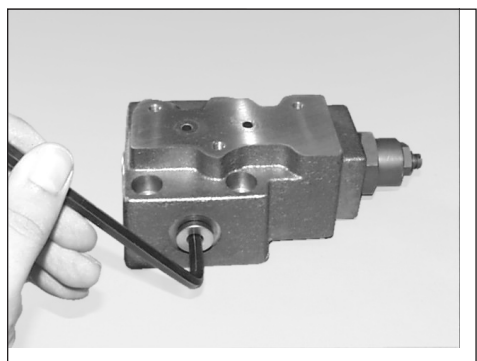

Figure 6a.

by using an adjustable wrench. Remove the differential spring, spring seat, external washer and snap ring.

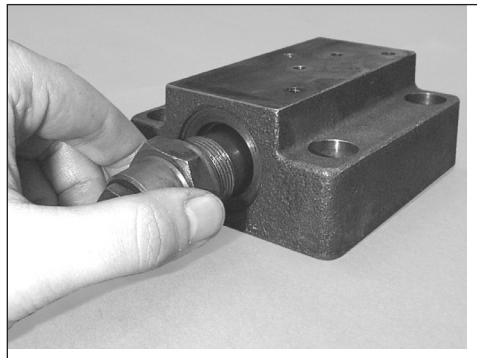

Figure 7.

8. Loosen the locknut on the adjustment housing and disassemble the adjustment stem with a screwdriver.



Figure 8.

9. Remove the compensator spool. Caution should be taken not to nick or mar the spool's surface.



Figure 9.

7. Remove the first stage adjustment screw adapter

Assembly Procedures – Two-Stage Compensator

Assembly Instructions

1. Thoroughly lubricate the compensator spool with clean hydraulic fluid. Make sure there are no burrs on the spool and insure that the spool has no residual magnetism. Spools that are magnetic will attract metallic particles and damage the compensator body or spool. Insert the compensator spool into the smaller opening of the first stage body by holding the squared end and inserting the round end first.

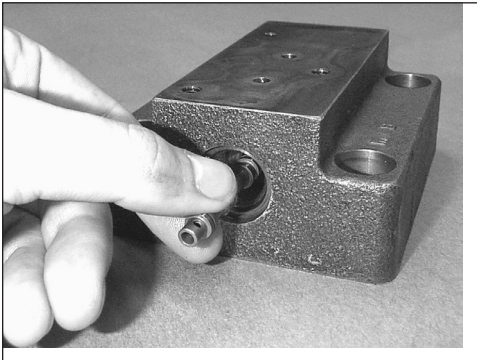

Figure 1.

2. Replace the O-ring and the back-up ring on the adjustment stem.



Figure 2.

2a. Replace the O-ring on the adjustment housing. Assemble the adjustment stem into the adjustment housing with a flat blade screwdriver.



Figure 2a.

3. Place the spring seat on the spring, then insert the spring and spring seat into the adjustment housing.

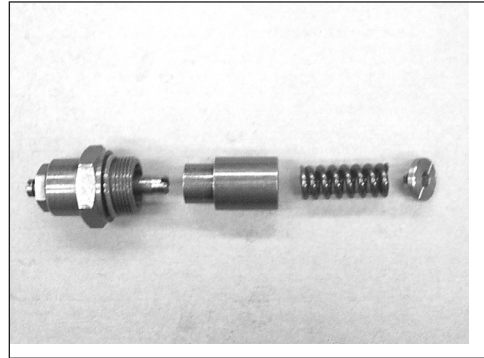

Figure 3.

4. Install the first stage differential spring adjustment screw adapter as one (1) assembly into first stage. Torque to 708-888 in.-lbs. (80-100 Nm).

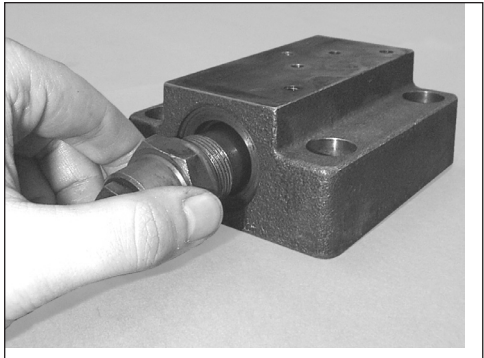

Figure 4.

5. Replace the back plug with the O-ring and insert it into the first stage compensator body. Torque to 442-531 in.-lbs. (50-60 Nm).

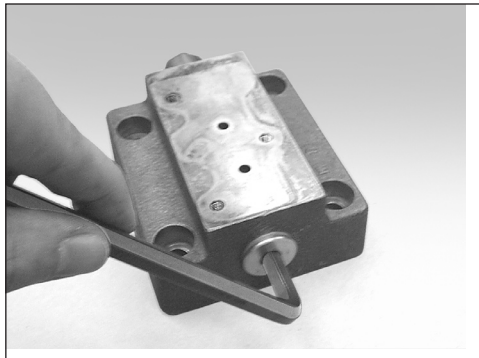

Figure 5.

Assembly Procedures – Two-Stage Compensator (continued)

5a. For PVX-8/11/15 pumps, replace the plug with the O-ring for the shock clipper on the first stage compensator and torque to 144-180 in.-lbs. (17-21 Nm).

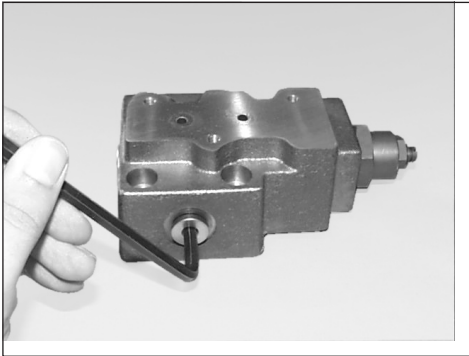

Figure 5a.

6. Replace the plug with the O-ring on the backside of the second stage compensator. Torque to 150-186 in.-lbs. (17-21 Nm).

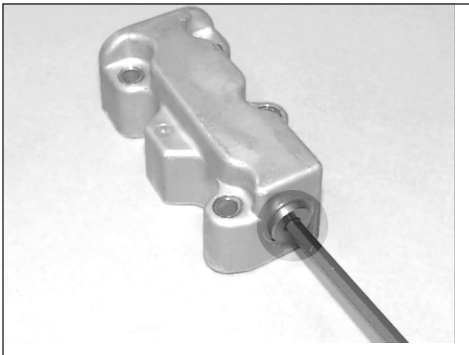

Figure 6.

7. Replace the poppet seat with the O-ring and insert it into the second stage compensator body using a large screwdriver. Avoid damaging any of the O-ring sealing surfaces. Torque to 168 in.-lbs. (19 Nm).



Figure 7.

8. You may place the compensator upright to insert the guided poppet into the second stage compensator. Make sure that the poppet and poppet seat are not damaged or nicked or the compensator will not function properly.

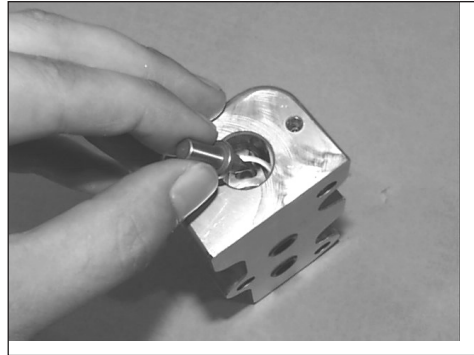

Figure 8.

8a. Place the spring into the second stage compensator.



Figure 8a.

9. Replace the O-ring and the back-up ring of the pressure adjustment locknut.

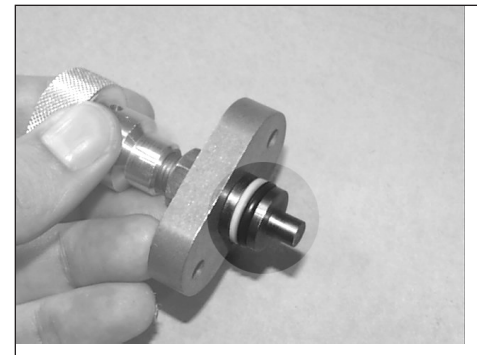
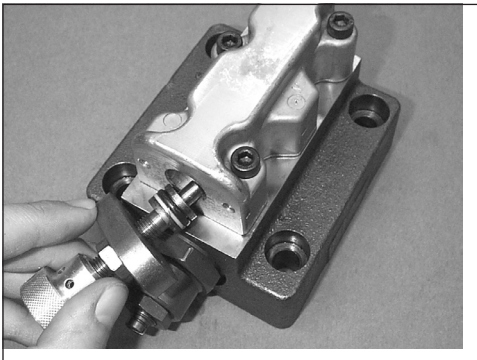

Figure 9.

**Assembly Procedures – Two-Stage Compensator
(continued)**

9a. Mount the pressure adjustment assembly to the second stage compensator.



Figure

9a.

10. Torque the two (2) socket head cap screws to 44-62 in.-lbs. (5-7 Nm).



Figure 10.

11. Prior to mounting the second stage to the first stage body, insure that all O-rings are in place on the mating surface of the second stage body. A minimum amount of grease or petroleum jelly may be used to retain the O-rings during placement.

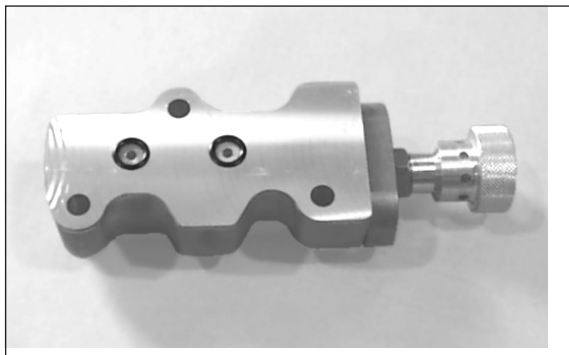

Figure 11.

11a. Mount the first stage to the second stage body. Torque the three (3) socket head cap screws to 129-171 in.-lbs. (15-20 Nm).

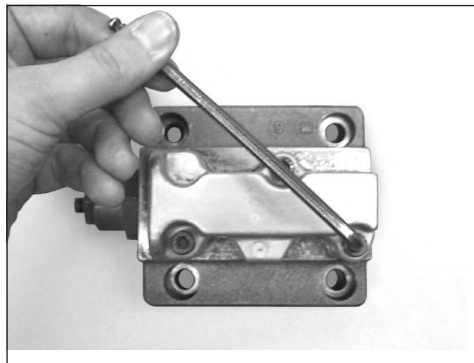

Figure 11a.

12. Replace the O-rings on the backside of the compensator.

O-Ring Quantities

Ref.	PVX Model	
	8/11/15	20/29/36/46/60/75
4	2 small O-ring	3 small O-ring
5	1 large O-ring	1 large O-ring

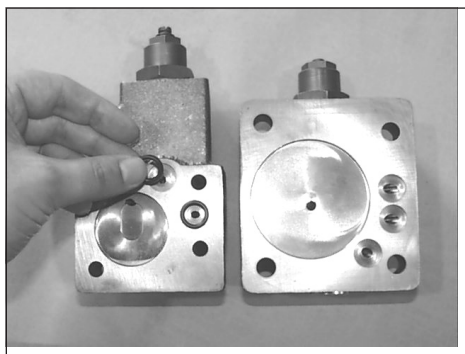

Figure 12.

Disassembly Procedures – Single Stage Compensator

General

Shown below is the Continental Hydraulics single stage compensator. Following are the complete disassembly procedures. The single stage control is normally available on the PVX-8/11/15 pumps only.

The step number corresponds to the photo or illustration of the same number.
Any dimensions or values stated will have the English value first followed by the metric equivalent in parenthesis.

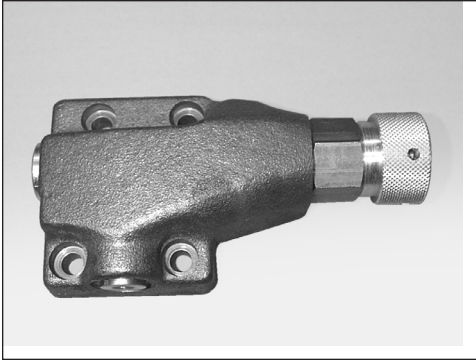

Disassembly Instructions

1. Remove the roll pin on the backside of the compensator. Use a hammer and a small punch to drive the pin out. then remove it with pliers.

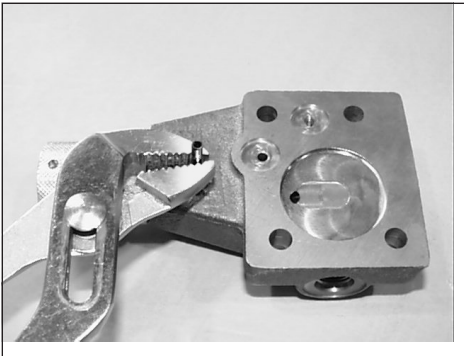
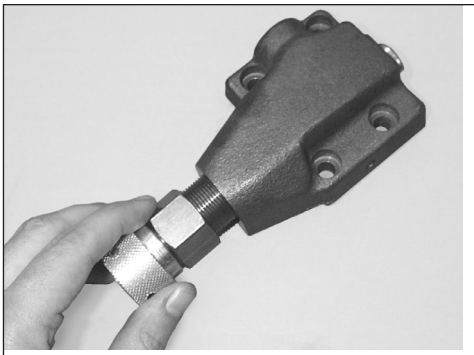

Figure 1.

2. Remove the adjustment knob, including the spring and spring seat as one (1) assembly.



Figure

2.

3. Remove the hex. head plug on the side of the single stage compensator by using the appropriate Allen wrench.



Figure 3.

4. Remove the hex. head plug opposite to the adjustment knob by using the appropriate Allen wrench.

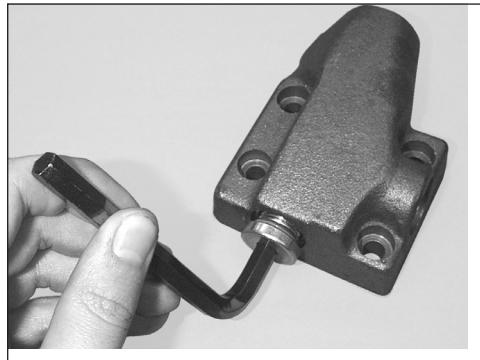

Figure 4.

5. Insert an Allen wrench to remove the compensator spool.

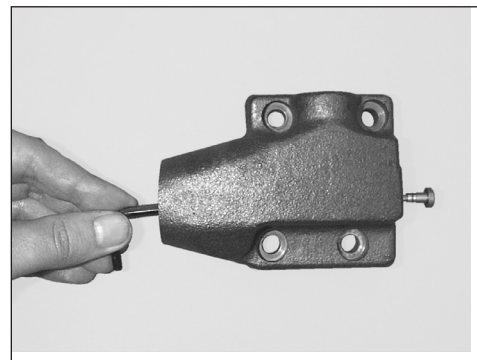

Figure 5.

Assembly Procedures – Single Stage Compensator

General

To guarantee proper operation of the single stage compensator, Continental Hydraulics recommends relacing all compensator seals included in the CHD Compensator Seal Kit.

The step number corresponds to the photo or illustration of the same number.
Any dimensions or values stated will have the English value first followed by the metric equivalent in parenthesis.

Getting Started - Kits

COMPLETE ASSEMBLY FOR SINGLE STAGE COMPENSATOR	
SAE	264404



Assembly Instructions

1. Thoroughly lubricate the compensator spool with clean hydraulic fluid. Insert the compensator spool into the single stage body by holding the rounded end and inserting the small round end first.

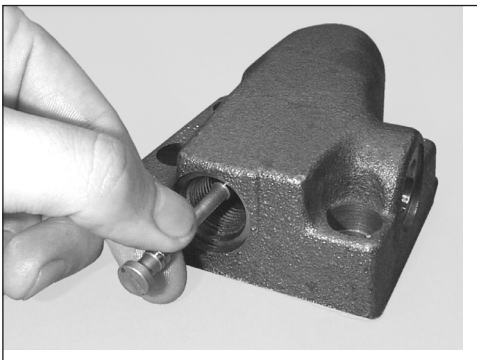

Figure 1.

2. Replace the O-ring and the back-up ring on the adjustment knob.



Figure 2.

2a. Place the spring seat on the spring, then insert the spring and spring seat into the adjustment knob.

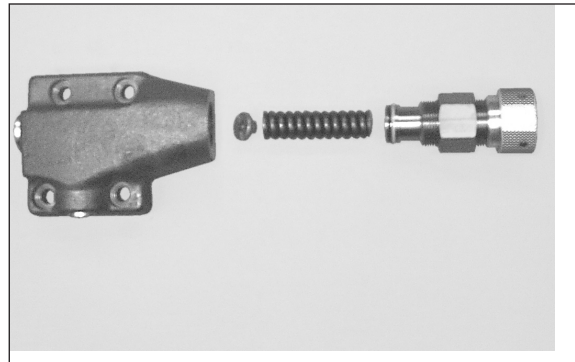

Figure 2a.

3. Insert the adjustment knob.

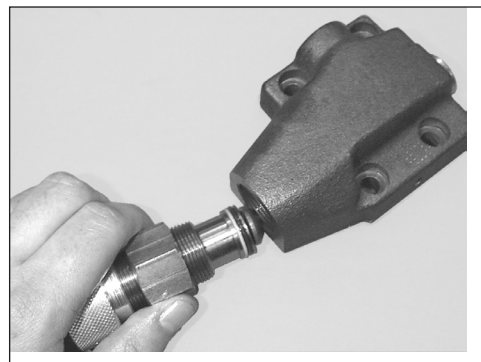

Figure 3.

**Assembly Procedures – Single Stage
Compensator (continued)**

4. Replace the O-ring on the hex. head plug and insert it into the compensator on the opposite side of the adjustment knob. Torque to 283-369 in.-lbs. (33-43 Nm).

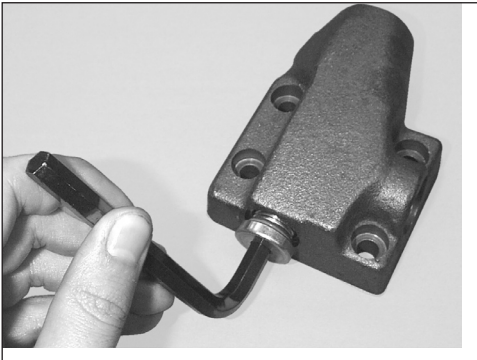

Figure 4.

5. Replace the shock clipper plug including the O-ring on the side of the single stage compensator and insert it by using the appropriate Allen wrench.



Figure 5.

6. Insert the roll pin on the backside of the single stage compensator.

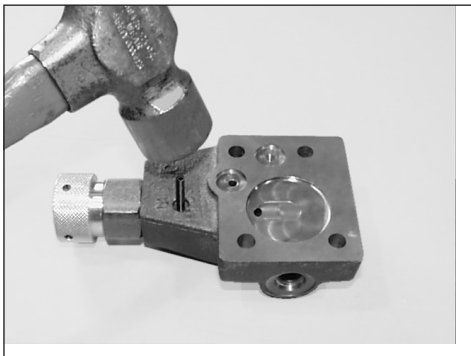

Figure 6.

7. Replace the O-rings on the backside of the compensator.

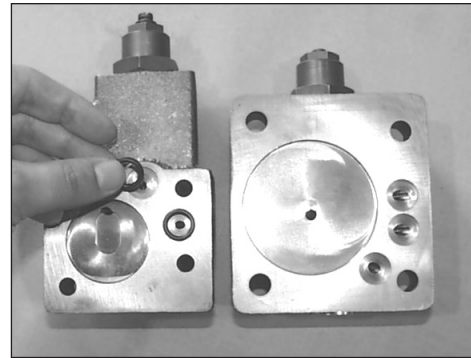

Figure 7.

Proper Setting of the Thrust Screw

Adjustment Instructions

1. Make sure the pump is in “deadhead” condition before attempting adjustment of the thrust screw. The “deadhead”, or compensated condition, can be reached by blocking the outlet port by shutting off downstream valves which means that the output flow is blocked. The output flow must be completely shut off. Any valve leakage will affect the proper setting of the pump.
2. Loosen the pressure adjustment locknut on the compensator.
3. Back off the pressure adjustment to its absolute minimum (until it stops) by turning counterclockwise. On a two-stage control, this adjustment is on the second stage (the top assembly).
4. If your pump has a torque limiter control, back out the torque limiter adjustment all the way.
5. Using a flat blade screwdriver, back out the first stage adjustment to its absolute minimum (until it stops).
6. The chart below shows the minimum thrust screw settings and differential pressure settings.

Two-Stage Compensator (1800 rpm)

PVX Model	Thrust Screw	Differential Setting (First Stage)
PVX-8	170-190 psi (12-13 bar)	
PVX-11/15	190-205 psi (13-14 bar)	100-110 psi
PVX-20/29/36	230-250 psi (16-17 bar)	(7-7.5 bar)
PVX-46/60/75	210-230 psi (14-16 bar)	

- On PVX-8/11/15 pumps, the shock clipper port must be blocked when calibrating the pump. The first stage setting is always additive to the thrust screw setting.

Thrust Screw Setting + Differential Setting (1st Stage) = Total Minimum Setting

Example for PVX-75 (1800 rpm, 3000 psi):

1st adjustment - Thrust Screw Adjustment	210-230 psi
2nd adjustment - Differential Spring (1st stage)	100-110 psi
Total Minimum Setting	310-340 psi

Example for PVX-75 (1800 rpm, 210 bar):

1st adjustment - Thrust Screw Adjustment	14-16 bar
2nd adjustment - Differential Spring (1st stage)	7-7.5 bar
Total Minimum Setting	21-23.5 bar

7. If you are working on a PVX-8/11/15 pump, make sure the shock clipper port is blocked (located on the side of stage one, the lower section of the two-stage control) before adjusting the thrust screw. For PVX-20 thru 75, there is no external shock clipper port, therefore proceed to the next step.
8. If the pump has a stroke limiter, also known as a maximum flow limiter or volume control, make sure it is backed out all the way. This is done by turning the bolt at the position on the pump housing opposite the pump control.
9. To adjust the thrust screw, loosen the thrust screw locking nut. For PVX-8/11/15 pumps, a 5/16" Allen wrench is required; for PVX-20 thru 75, a spanner wrench.
 - While observing a pressure gauge, turn the thrust screw clockwise to increase pressure, counterclockwise to decrease it, to the appropriate thrust screw pressure setting from the chart. Be careful, the thrust screw should not be turned more than a 1/4 turn in either direction.
 - Once the proper minimum thrust screw pressure is set, then adjust the differential pressure on the first stage compensator with a flat blade screwdriver. Adjust the first stage differential screw 110 psi (7.5 bar) over the thrust screw setting.
 - It is useful to “jog” the pump from deadhead to full flow several times and then recheck the thrust screw setting to assure repeatability.
10. Turn the second stage compensator knob in to the desired pressure and lock the setting with the jam nut.
11. Replace the locknut on the thrust screw and tighten securely.

Adjustment Procedures – Single Stage Compensator

General

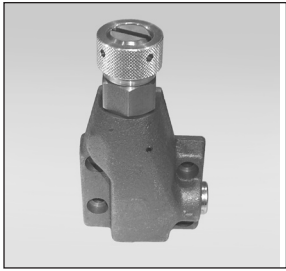

The single stage compensator consists of a spool, spring and adjusting screw, which are assembled in a body and bolted to the pump body. To control the pressure at the control piston, the spool is designed to meter flow fluid

in and out of the control piston chamber. A hole is drilled about three-fourths the length of the spool and intersects with a hole drilled at a right angle to the spool axis. The purpose of these holes is to allow fluid from the pressure port of the pump to the end of the spool. No matter what position the spool is in, system pressure is applied to the end of the spool, creating a force, which opposes the spring force. As the system pressure increases, the force on the end of the spool also

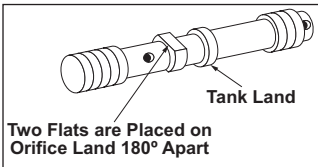

increases and the balance of forces determines the spool position. The spring cavity of the compensator is drained to the tank to prevent any pressure buildup from leakage, which would add to the spring force and change the compensator setting.

Spool Position	Pump Condition	System Condition
1	Full Flow	System Pressure < Compensator Setting
2	Deadhead	System Pressure > Compensator Setting

The compensator spool is really an infinite positioning servo valve held offset by the compensator adjusting spring and activated by system pressure. To simplify the explanation, the spool travel will be broken down into two (2) finite positions as shown below. When there is no resistance to pump flow, the spring will force the spool into the spring offset or “bottomed out” position shown.

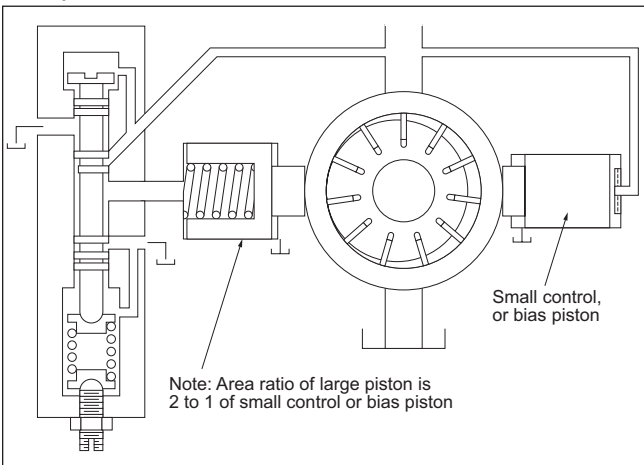

Offset or “bottomed out” position.

In this position, fluid from the pressure port can flow through the compensator to the control piston and allow system pressure to be applied to the control piston. A land on the spool (tank land) prevents the fluid in the control piston chamber from flowing to the tank. Because the control piston has twice the area of the bias piston and the same pressure is applied to both pistons, the greater force exerted by the control piston will force the ring into the flow or “on-stroke” position. The length of the bias piston, which bottoms out against the bias cover and prevents the ring from over-stroking and hitting the rotor, establishes the maximum flow rate.

As the resistance to pump flow increases, the pressure will be sensed on the end of the spool and when the force exerted is great enough to partially compress the spring, the spool will move. The ring will remain in the flow or “on-stroke” position because the tank line is still blocked and fluid can flow to the control piston through an orifice created by two (2) flats ground on the adjacent land (orifice land).

When the system pressure reaches the compensator setting (spring precompression), the spool will move to position #2 which meters fluid out of the control piston chamber as well as into it.

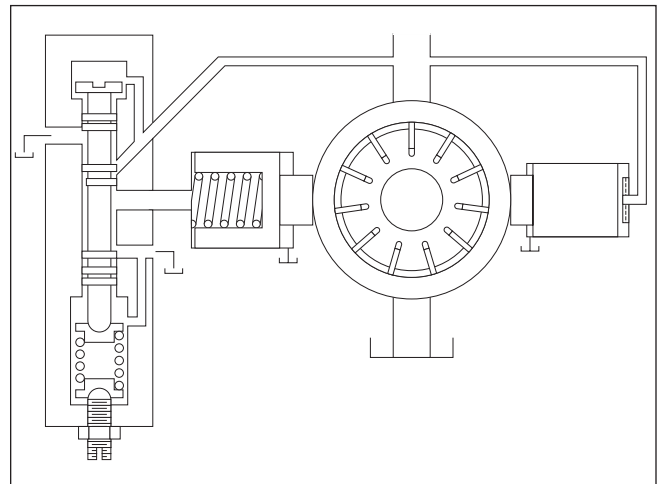

Position #2 - Deadhead.

Adjustment Procedures – Single Stage Compensator (continued)

The further the spool moves, the greater the amount of fluid bled off from the control piston chamber across the variable orifice created by the tank land. Since the flow of fluid to the control piston is limited by the orifice created by the flats on the pressure land, the pressure in the control chamber has dropped to approximately half of the outlet pressure, the bias piston force will exceed the control piston force move the ring off-stroke, reducing flow. As the ring shifts, the flow rate out of the pump is being reduced and the compensator is positioning the ring to find the exact flow rate necessary to maintain the pressure setting of the compensator. If the pump flow becomes blocked, the ring will continue to be destroyed until the deadhead or no-flow position is reached. Remember that system pressure is always applied to the bias piston, which is trying to push the ring off-stroke. A balance of forces of the control piston verses bias piston determines the ring position.

To set-up a single stage compensator, follow the instructions given in the previous section "*Proper Setting of the Thrust Screw*". Once the thrust screw pressure is set, adjust and lock the compensator knob at the maximum compensating pressure of your system.

Adjustment Procedures – Two-Stage Compensator

General

The two-stage compensator works exactly the same as the single stage control. However, instead of loading the spool with a spring, it is hydraulically loaded. To do this, a small relief valve referred to as the second stage is connected to the spring chamber.

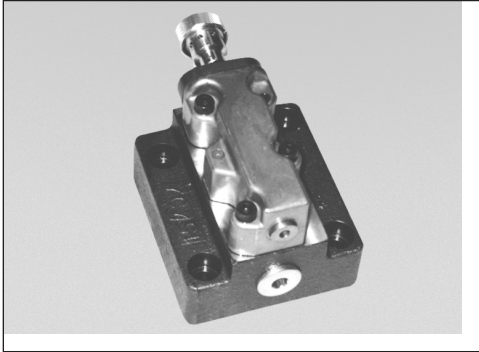

Two-Stage Compensator.

Two (2) additional flats are ground on the land at the end of the spool which will allow fluid to flow into the spring chamber.

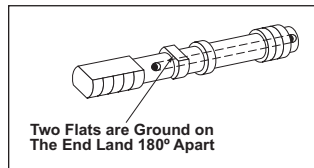

If there is a pressure spike in the system above the compensator setting, the spool will momentarily move to the over travel position in an effort to destroke the pump. Only in position #2 is it a true compensating condition. Do not be confused with the term "deadhead", it means the same thing as compensating.

When the spring in the second stage is compressed, it will hold the poppet in its seat and block the flow to the tank. With the flow blocked, the pressure at the bottom of the spool will be the same as the pressure at the top. Remember that pressure is equal throughout a static fluid. Since the area at the ends of the spool are equal, the hydraulic forces created are equal but opposite in direction and cancel each other out. To unbalance the forces, a light bias spring is added which pushes the spool into the bottomed-out position shown. With the spool in this position, system pressure is applied to the control piston and will push the ring on-stroke as it did in the single stage control.

As system pressure increases, the pressure at the end of the spool is always equal until it reaches the second stage setting. At that point, the relief valve (second stage) will open and limit the pressure in the bias spring chamber by allowing fluid from the chamber to flow to the tank. This will limit the amount of hydraulic force applied to the bottom end of the first

stage spool. Fluid that is under pressure always takes the path of least resistance and, when the second stage opens, the entire pump flow is going to try to flow through the compensator to the tank. To get to the tank, the fluid must flow through the very small flats ground on the end of the spool. As the entire pump flow tries to flow through the flats, they offer resistance to the flow, the pressure upstream of the flats is increased. This pressure is sensed at the top of the spool and, as the pressure increases, the hydraulic force pushing down on the spool increases. When this force becomes greater than the hydraulic force at the bottom, plus the bias spring force, the spool will be pushed towards the bias spring and vent the pressure behind the control piston to the tank. The pump will then compensate as it did with the single stage control.

Full Flow Position.

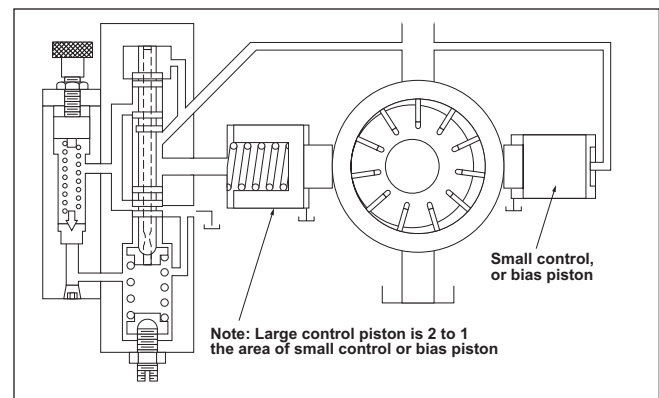

To set-up a two-stage compensator, follow the instructions given in the previous section "Proper Setting of the Thrust Screw". Once this is done, adjust and lock the compensator knob at the maximum compensating pressure of your system.

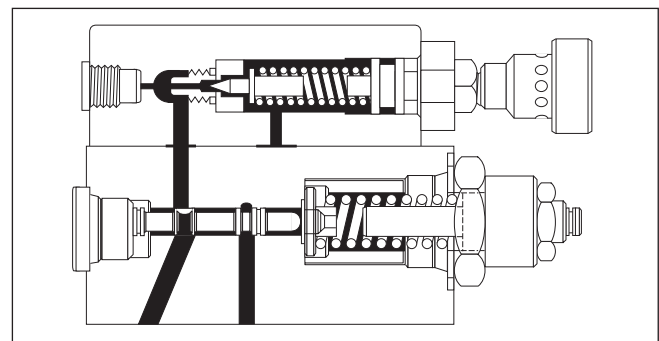

Two-Stage Compensator Cut-Away View.

Multi-Pressure Compensator

General Information

Multi-pressure pump control can markedly reduce horsepower demand and heat generation during periods of idle time or time in the machine operating cycle when maximum pressure is not required. The modular design of the standard two-stage compensator lends itself to variable preset multi-pressure control arrangements with integral or remotely located valving. Whenever remote relief valves and switching valves are used, care must be taken not to introduce too much contained fluid between the pump and the remote valving.

Severe reduction of the pump reaction time constants or erratic control may occur with lines larger than 1/4" (6 mm) O.D.T. or of lengths exceeding 20 feet (610 cm). Special circuits might be needed in certain cases to alleviate problems, including the use of orifices at each end of the remote line.

Solenoid Two-Pressure Control

The illustration below shows the construction of the solenoid two-pressure compensator. The upper second stage is the high pressure control and serves to limit the maximum desired circuit pressure. The lower second stage contains either a normally open or normally closed two-way valve which is energized to select which of the two second

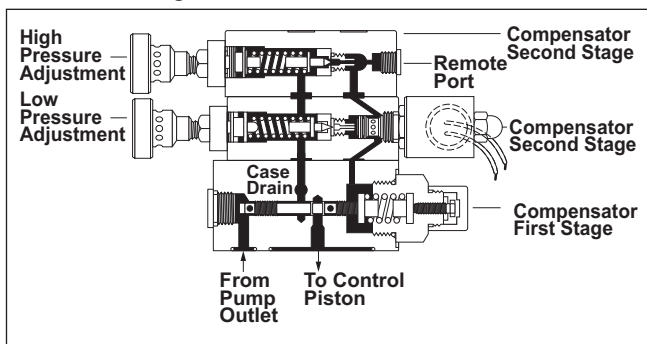
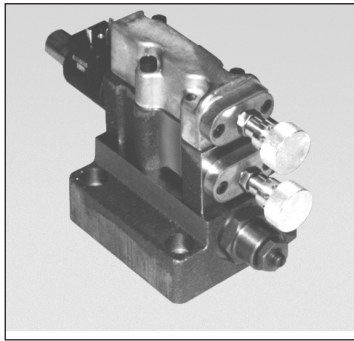

stages will have control of the pump.
Solenoid Two-Pressure Compensator.

To adjust a solenoid operated two-pressure control, determine if the solenoid is normally open (N.O. means low pressure) or normally closed (N.C. means high pressure). The hydraulic code on the pump name plate will identify which type of solenoid is on the compensator, assuming that the pump and compensator have not been modified from the factory.

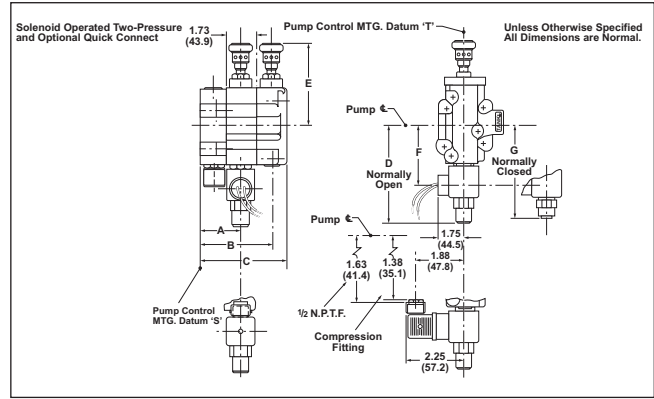

Solenoid Two-Pressure & Optional Quick Disconnect.

An example hydraulic code of a two-pressure control is: PVX-60B25-XX-XX-2724-A. In this example, the **27** identifies the pump as a two-pressure compensator with a **normally open** solenoid. If the code had a **28** in this place, the solenoid is **normally closed**.

The solenoid must be closed to begin compensator adjustment. If the solenoid is normally closed, leave the solenoid de-energized. If the solenoid is normally open, energize the solenoid to close. Use the following steps to adjust the compensator:

1. Back out both the low pressure and high pressure adjusting knobs all the way.
2. Back out the first stage adjusting screw all the way.
3. Follow the procedure to set the thrust screw setting as detailed in the section "Proper Setting of the Thrust Screw".
4. Follow the procedure to set the first stage setting as detailed in the section "Proper Setting of the Thrust Screw".
5. With the solenoid closed, adjust the high pressure adjusting knob to set the maximum compensating pressure of the pump. Tighten the locknut on the adjusting screw to fix this pressure.
6. The solenoid must be opened to adjust the low pressure setting. After opening the solenoid (energize if N.C. or de-energize if N.O.), adjust the low pressure adjusting knob to set the second (i.e. low) pressure on the pump. Tighten the locknut on the adjusting screw to fix this pressure.

Multi-Pressure Compensator (continued)

Solenoid Vented

The following illustration shows the solenoid vented compensator. Once again, the solenoid must be closed to begin compensator adjustment.

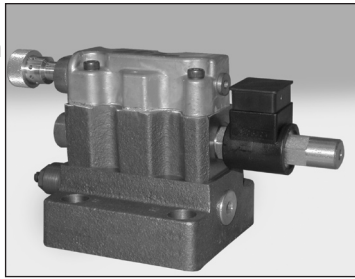

Solenoid Vented Compensator.

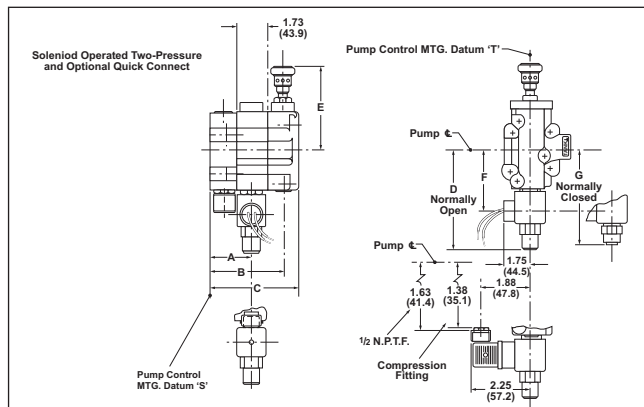
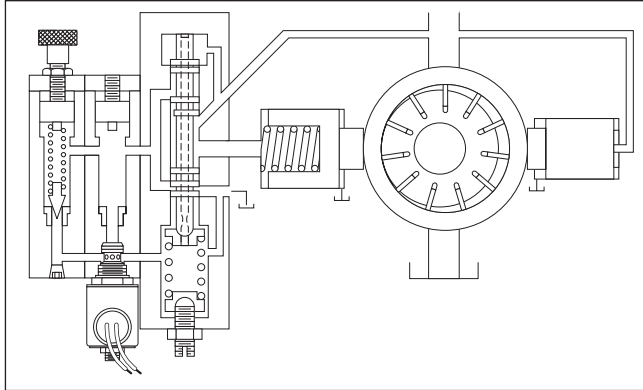

Using the hydraulic code on the pump name plate, determine if the solenoid is normally open or closed. An example hydraulic code of a vented control is: PVX-60B25-XX-XX-**29**24-A. In this example, the **29** identifies the pump as a vented compensator with a **normally open** solenoid. If the code had a **30** in this place, the solenoid is **normally closed**.

If the solenoid is normally closed, leave the solenoid de-energized. If the solenoid is normally open, energize the solenoid to close. Use the following steps to adjust the compensator:

1. Back out both the low pressure and high pressure adjusting knobs all the way.
2. Back out the first stage adjusting screw all the way.
3. Follow the procedure to set the thrust screw setting as detailed in the section "Proper Setting of the Thrust Screw".

4. Follow the procedure to set the first stage setting as detailed in the section "Proper Setting of the Thrust Screw".
5. With the solenoid closed, adjust the high pressure adjusting knob to set the maximum compensating pressure of the pump. Tighten the locknut on the adjusting screw to fix this pressure.
6. To check the solenoid vent pressure, the solenoid must be opened. After opening the solenoid (energize if N.C. or de-energize if N.O.), the system pressure should decrease to the first stage setting.

Load Sense

The purpose of the load sensing flow compensator (LSFC) is to maintain constant flow regardless of changes in load or pump shaft rotational speed. This is accomplished by

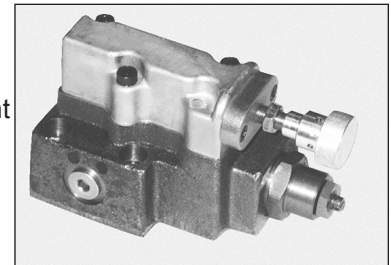

using an external metering valve and continually sensing pressure drop across this valve with a pilot line. The pump becomes a "control element" with this option, very similar to a very accurate pressure compensating flow control. However, because manipulation of the hydraulic power source is extremely efficient and the pump only uses precisely enough pressure to accomplish the task, the LSFC is very energy conserving. Accuracy of the LSFC is +2 - 5% of set flow rate over the full range of load pressure. A changeable orifice is installed as standard and built into the compensator body.

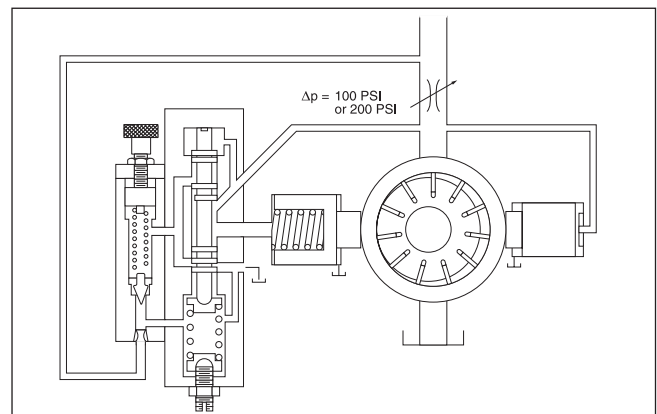

Load Sense Flow Compensator (LSFC).

Multi-Pressure Compensator (continued)

The two-stage pressure compensator module is the basic foundation for the LSFC. The control seeks to maintain a constant pressure drop across a remote orifice. Any increase in flow due to decreasing load or increase in pump shaft rpm will cause an increase in the differential pressure. The PVX load sense ΔP is factory set at 100 psi (7 bar) for PVX-8 thru 36 pumps and 200 psi (14 bar) for PVX-46 thru 75 pumps. The opposite control action occurs smoothly should the ΔP fall below this differential setting, dynamically changing ring position to adjust to any differential pressure changes. Constant velocity of the load under widely varying pressure conditions results.

Should the load stall or otherwise be restricted from movement or use of fluid, the pressure compensator as secondary control will take over and maintain deadhead pressure until the problem is corrected. Should the remote valve be totally closed, the pump will go to minimum deadhead.

The sensing pilot line P1, which is downstream, connects to the compensator shown in the illustration. A #4 SAE connector for P1 has a 0.040 inch (1.0 mm) orifice in it to dampen out any tendency to oscillate for sense lines of 1/4 inch (6 mm) tubing up to eight (8) feet (243.8 cm) long. Additional 0.030 inch (0.8 mm) orificing in each line might be necessary for longer lines. Sense lines should be hard tubing of approximately equal length and 1/4 inch (6 mm) diameter tapped into the main line, at least 10 pipe diameters upstream and downstream of the remote orifice. If located too close to the remote orifice, turbulent flow might be created erratic action. Thorough air bleeding of the sense lines is absolutely essential to proper operation.

The quality of the remote valve is very important to the accuracy and stability of the LSFC. Successful valves used are standard flow control valves and electro-hydraulic proportional flow controls of many types.

All orifices must be non-pressure compensated and sharp edged for temperature stability. If only low accuracy is needed, the ΔP of a four-way valve or other two-way valve is generally useable. Remember that at least 100 psi (7 bar) for PVX-8 thru 36 pumps; 200 psi (14 bar) for PVX-46 thru 75 pumps ΔP must be developed at the minimum flow rate or the LSFC will not work well.

The following graphic illustration shows a flow versus pressure characteristic curve. The curve shows that two (2) shaded areas must be avoided! First, flow rates below 10% of maximum output at rated rpm and second, pressures below minimum deadhead, generally 400 psi (28 bar) on 3000 psi (210 bar) rated pumps. Flat flow lines extend from minimum deadhead to approximately 100 psi (7 bar) below the setting of the pressure compensator, at any flow rate within the limits of maximum to 10% of maximum capability.

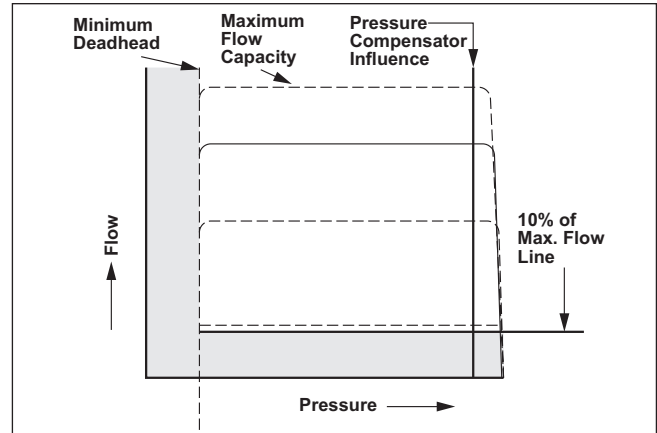

Flow Versus Pressure Characteristic Curve.

The LSFC is intended for and should be applied on meter-in circuits only. Meter-out circuits could pose serious safety problems or design difficulties because of the P1 sense line location downstream of the orifice. This puts P1 at atmospheric or at tank line pressure, which can vary drastically. Please do not apply LSFC equipped pumps on meter-out circuits unless the factory advises otherwise.

Multi-Pressure Compensator (continued)

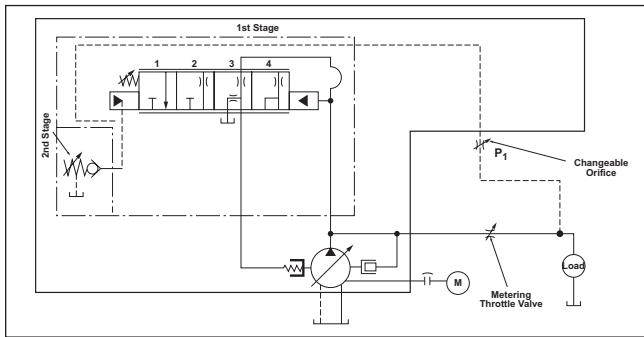

Load Sensing Flow Compensator Schematic.

LSFC Condition	Valve Position	Condition	System Condition
Rated ΔP	3	On stroke to set flow	Constant flow close deadhead
Above Rated ΔP	4	Minimum deadhead	External orifice shut-off
Below Rated ΔP	2 to 1	Full deadhead	External orifice open beyond pump displacement
Zero ΔP	3 to 4 Compensator Override	Deadhead	Load resistance above compensator setting

The procedure to set-up a load sense control is essentially the same as the procedure to set-up a two-stage control. The differential setting (first stage adjustment) must be set to a minimum of 100 psi (7 bar) for PVX-8 thru 36 pumps; 200 psi (14 bar) for PVX-46 thru 75 pumps, above the thrust screw setting. This ΔP can be increased to 200 psi (14 bar) for better operation, but this higher differential setting does increase the minimum compensating pressure at which the pump can operate at. Therefore, the higher differential setting should only be used if low pressure compensating is not a concern for your system.

Torque Limiter

The torque limiter control is only available on PVX-20 thru 75 pumps and with SAE connections. If your application requires BSPP connections, please contact the factory for availability.

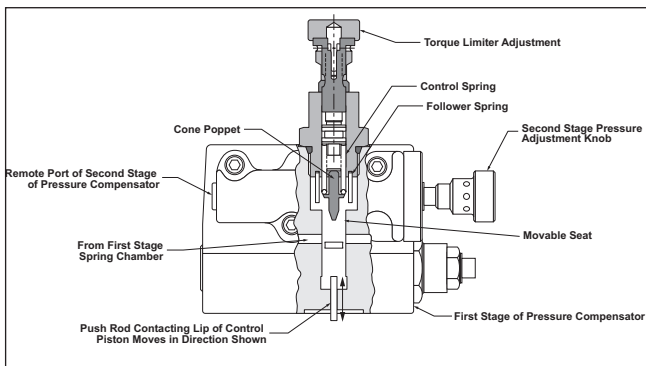

Torque Limiter.

The torque limiter control has two (2) customer settable adjustments: the second stage pressure adjustment (knurled knob parallel to the inlet/outlet ports) is used to set maximum deadhead pressure of the pump. A family of pressure cut-off curves are achievable using this adjustment. Clockwise adjustment increases the maximum deadhead pressure, while counterclockwise adjustment decreases it.

The other adjustment is the torque limiter adjustment (knurled knob perpendicular to the inlet/outlet ports) and it is used to set the torque cut-off curves. A family of torque cut-off curves are achievable using this adjustment. Clockwise adjustment increases the torque cut-off point, while counterclockwise adjustment decreases it.

It is also possible to use a torque limiter control as a standard two-stage pressure compensator up to the maximum full-flow pressures as shown in this chart.

PVX Model	psi (bar)
20	2250 (155)
29	2250 (155)
36	1750 (121)
46	2250 (155)
60	2250 (155)
75	1500 (103)

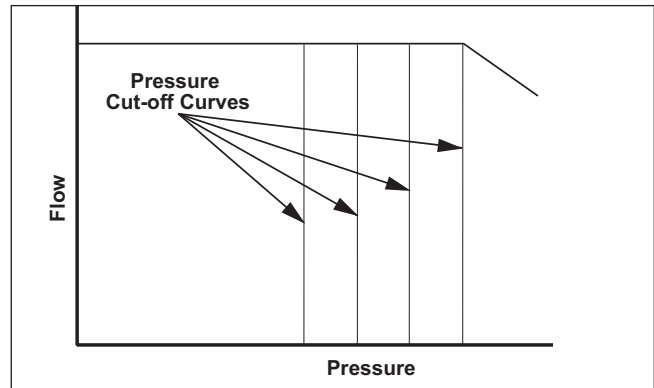

Torque Limiter Control Up to Maximum Full Flow Pressures.

The illustration below shows the second stage pressure adjustment (pressure cut-off curve) will override the torque limiter adjustment (torque cut-off curve) when the two intersect. This feature limits the maximum pressure of the pump.

Multi-Pressure Compensator (continued)

The illustration below shows the second stage pressure adjustment (pressure cut-off curve) will override the torque limiter adjustment (torque cut-off curve) when the two intersect. This feature limits the maximum pressure of the pump.

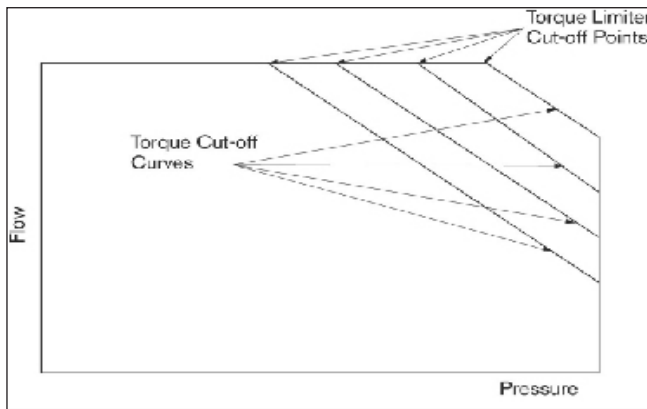

Second Stage Pressure Adjustment Overriding Torque Limiter Adjustment.

The illustration below shows that it is possible to set the torque limiter cut-off point to a level where the pressure cut-off curve is not reached. In this case, the maximum deadhead pressure is limited by the torque limiter cut-off adjustment. It can also be seen that the torque limiter cut-off point can be set to a level where maximum output flow of the pump can not be achieved.

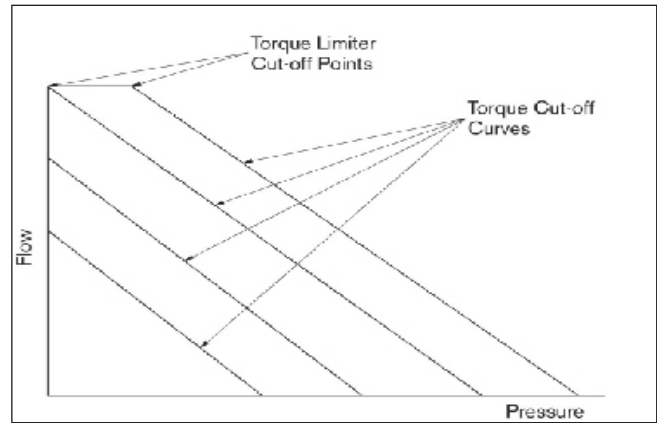

Second Stage Pressure Adjustment Torque Limiter Cut-Off Point Where the Pressure Cut-Off Curve Not Reached.

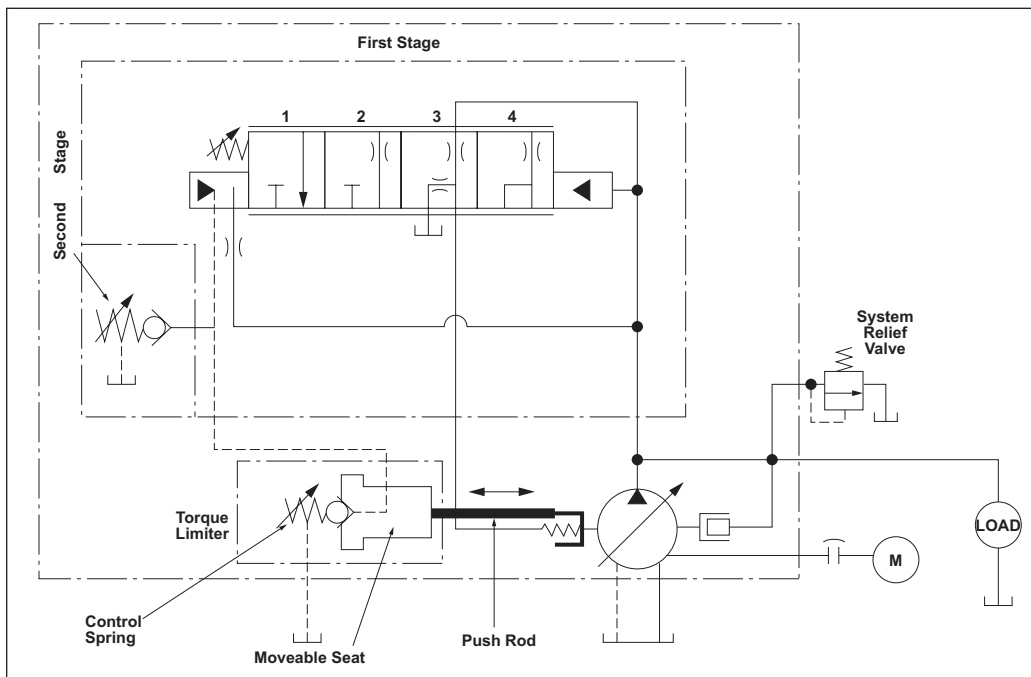

Torque Limiter Schematic.

Torque Limiter	Valve Position	Condition	System Condition
Poppet Seated	1	Free Flow	No Resistance
Poppet Opening	2	Full Flow	Resistance Starting
Poppet Metering	2 to 3	Reduced Stroke	Resistance Increasing
Poppet Metering	3	Deadhead	Blocked
Poppet Open	4	Spool Over Travel	Shock Pressure Above Deadhead

Multi-Pressure Compensator (continued)

Setting the Maximum Deadhead Pressure (Second Stage Setting)



PVX torque limiter adjustment stems that have the adjustment knob removed pose special concerns when the pump is restarted. Some internal control components can be damaged if the torque limiter is not adjusted properly. Please consult the factory if this condition exists.

1. If you received a pump straight from the factory, skip to step 7. Otherwise, proceed with the following steps:
2. Before starting the pump, complete the following operations:
 - Back out (counterclockwise) the second stage of the compensator all the way.
 - Turn the torque limiter adjustment knob fully out (counterclockwise).
3. Start the pump running into an open circuit under minimal load and at normal operating temperature.
4. If the pump is not prime, turn the thrust screw clockwise in small increments until the pump primes.
5. Close a load valve in the circuit such that the pump has no output flow (i.e. deadhead condition).
6. Follow the procedure to set the thrust screw setting and the first stage differential setting as detailed in the section "Proper Setting of the Thrust Screw".
7. Torque limiter pumps straight from the factory should already have the proper thrust screw and first stage settings. With the pump operating in deadhead, turn the torque limiter adjustment knob fully in (clockwise). This will set the torque limiter function out of the way such that the second stage pressure adjustment can be made.
8. Adjust the second stage pressure adjustment to the desired maximum deadhead pressure and lock in place with the jam nut. Proceed to setting the torque limiter adjustment.

Setting the Torque Limiter

1. With the pump still in deadhead, adjust the torque limiter knob out (counterclockwise) as follows:
 - PVX-20/36/75 1-1/2 full turns
 - PVX-29/46/60 2 full turns
2. Turning the torque limiter adjustment out by this amount will assure a low torque setting when the circuit is open.
3. Take the pump out of deadhead by opening the circuit.
4. Load the hydraulic circuit and check to see if the desired flow/pressure/torque requirements of your system are achieved.
5. To adjust the torque limiter settings, turn the torque

limiter adjustment knob in for higher torque and out for less torque in small increments.

6. Continue this process until the desired conditions are achieved.
7. Lock the jam nut under the torque limiter knob.

Application Notes

1. When the torque limiter adjustment is fully backed out or near its lowest setting, the pump may not reach full flow.
2. Putting a flow and pressure load on the pump with the torque limiter adjusted fully in may cause the pump motor to stall or be damaged if the motor is undersized for full flow and high pressure.
3. It is possible for the torque limiter to control the maximum deadhead pressure of the pump. This condition can occur if the torque limiter curve reaches zero output flow before the second stage maximum deadhead pressure is achieved.

Maximum Flow Limiter

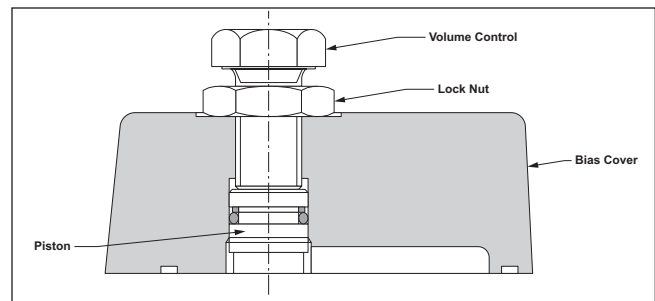

Maximum Flow Limiter.

Maximum Flow Limiter			
Pump Model	Nominal Stroke	Decrease in Flow Per turn	Minimum Flow Attainable
PVX-8	0.075" (1.9 mm)	53%	< 0%
PVX-11	0.080" (2.0 mm)	50%	0%
PVX-15	0.099" (2.5 mm)	40%	20%
PVX-20	0.077" (1.9 mm)	80%	< 0%
PVX-30	0.106" (2.7 mm)	56%	8%
PVX-36	0.132" (2.4 mm)	44%	26%
PVX-46	0.117" (3.0 mm)	50%	17%
PVX-60	0.150" (3.8 mm)	40%	34%
PVX-75	0.186" (4.7 mm)	32%	47%

During initial start-up, volume should be at least 50% of maximum flow.

Only make adjustments to the volume control with the pump running at full flow and low pressure while observing output flow.

Fluids, Filters and System Preparation

General Information

Thorough system preparation is of the utmost importance if satisfactory component life is to be achieved. Sufficient care in system preparation and fluid selection, as well as filtration, can mean the difference between successful operation and shutdown.

Prior to installing the pump, the entire system, reservoir, cylinders, valving and all piping must be drained, flushed and filled with new or refiltered fluid. Once drained, the reservoir's inside surfaces must be cleaned of all chips, scale, rust, etc. All return and/or pressure line filter elements must be inspected and replaced if necessary. We do not recommend the use of suction strainers as they tend to be the leading cause of cavitation. If suction strainers are used, we recommend oversizing them.

Fluid Recommendations

Continental Hydraulics recommends the use of premium quality hydraulic fluids, such as Mobil DTE 25, DTE 26 or equivalent, with zinc anti-wear additives. The viscosity grade selected for your system should be based on the information shown on the chart below.

Fluid Temperature

Pump reservoir (bulk) fluid temperature should not exceed 140° F. (60° C.). Always select fluid for optimum viscosity at operating temperature. Maximum start-up viscosity should not exceed 4000 SUS (864 cSt).

Filtration

For increased component life, fluid contamination should not exceed 18/15 (up to 2000 psi or 140 bar), or 17/14 (from 2000 to 3000 psi or 140 to 210 bar), per ISO/DIS 4406 "Solid Particulate Contamination Code". We do not recommend the use of inlet strainers as they tend to be a leading cause of cavitation.

When converting your system from petroleum base fluids to water-glycol, water-in-oil emulsion, or synthetic fluids, contact the factory and/or your fluid supplier for system preparation instructions.

Continental Hydraulics recommend that the users of fire resistant fluids obtain a copy of the NFPA publication entitled "Recommended Practice – Hydraulic Fluid Power – Use of Fire Resistant Fluids in Industrial Systems"

PVX Model	Fluid Type ISO Classification	Oil (anti-wear)	Oil (anti-wear)	Phosphate Ester	Polyol Ester	Water- Glycol	FDA	Environmentally Acceptable HETG, HEPG, HEES, HEPR
		HM	HL	HFDR	HFDU	HFC	---	
		Note 1	Note 1 & 2	Note 3	Note 3	Note 3	Note 4	
8/11/15	Max. Press. psi (bar)	3000 (210)	3000 (210)	3000 (210)	3000 (210)	1500 (103)	1500 (103)	Note 5
	Min. Viscosity SUS (cSt)	100 (21)	100 (21)	100 (21)	100 (21)	100 (21)	100 (21)	
	Seal Material	Viton	Viton	Viton	Viton	Buna	Viton	
20/29/36	Max. Press. psi (bar)	3000 (210)	3000 (210)	3000 (210)	3000 (210)	1500 (103)	1500 (103)	Note 5
	Min. Viscosity SUS (cSt)	150 (32)	150 (32)	150 (32)	150 (32)	150 (32)	150 (32)	
	Seal Material	Viton	Viton	Viton	Viton	Buna	Viton	
46/60/75	Max. Press. psi (bar)	3000 (210)	2000 (140)	Note 5	Note 5	1500 (103)	1000 (70)	Note 5
	Min. Viscosity SUS (cSt)	150 (32)	150 (32)			150 (32)	150 (32)	
	Seal Material	Viton	Viton	Viton	Viton	Buna	Viton	

Notes:

1. Consult factory for detailed viscosity limits and approved oils.
2. Anti-wear oils are recommended, but not required, when operating at noted pressures.
3. Consult the factory for information pertaining to the use of Fire Resistant Fluids.
4. Maximum operating pressures are contingent upon the fluid used, as there is a wide range of fluid types that are FDA approved. Pressures listed are based on typical fluids. Please consult the factory.
5. Please consult the factory with viscosity information on these fluids.

Pump Installation Procedures

Installation Instructions

1. Remove all plastic protective cap plugs from the components before installation.
2. Prior to installation, Continental Hydraulics recommends pouring a small amount of clean hydraulic fluid into the pump inlet port. Then rotate the pump shaft by hand in the direction indicated by the arrow cast into the pump body. All Continental pumps rotate from thrust block to compensator (i.e. clockwise as viewed from the shaft end of the pump). This insures lubrication at initial start-up.
3. Mount the pump and drive motor to a rigid base not more than three (3) feet (91.4 cm) above the fluid level. Align the pump shaft to within 0.006 inch (0.152 mm) of full indicator movement of the motor shaft, as shown below.

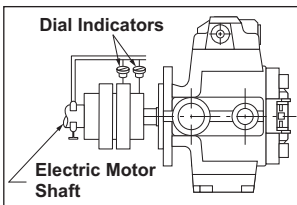

Proper Alignment #1.

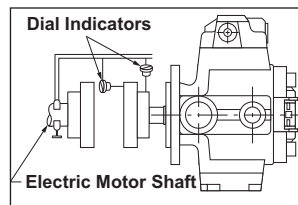

Proper Alignment #2.

- Two (2) precision dial indicators must be used to insure proper alignment in the vertical, horizontal and parallel planes. The coupling halves can be either engaged or disengaged.
- If disengaged, the outside diameter of the pump coupling must be smooth and machined true in respect to the coupling bore (illustration #1).
- In illustration #2, one (1) indicator rides the inside face of the pump coupling and is measuring parallel offset alignment, as in illustration #1.
- Proper alignment, with either method, is achieved when neither dial indicator varies more than 0.006 inch (0.152 mm) during one (1) complete revolution of the shaft.



The coupling selected should provide a clearance fit on the pump and motor shafts. Never use couplings with interference or sweat fits. Do not press jaw-coupling hub together tightly. Allow air gap between the hub and insert to prevent end thrust into the pump rotor, which will damage the pump. No external forces (other than rotational) should be applied to the shaft.

4. Carefully connect the inlet, outlet and drain plumbing to the pump. Do not force hard piping to align to the pump ports. This may pull the pump out of alignment with the motor.
 - The inlet line must be plumbed full size to within three (3) inches (76 mm) of the bottom of the reservoir. Never reduce or restrict the inlet.
 - Case flow on all PVX pumps exit through the port located on the pump body. PVX-8/11/15 models also have an external shock clipper drain port located on the compensator that, if you wish to enable the clipper feature, must be plumbed. PVX-20 thru 75 models have internal shock clipper drains and no additional plumbing is necessary.
 - The case drain line must also be plumbed to within three (3) inches (76 mm) of the bottom of the reservoir. The case drain and main system return lines must be separated from the pump inlet line by a baffle. This enables all return flow to travel the length of the reservoir before entering the pump again, allowing heat dissipation and deaeration.
5. The case drain lines from multiple pump in a combination should independently be plumbed back into the reservoir to prevent problems. Continental Hydraulics recommends not to install check valves in case drain lines if possible. If so, Continental strongly suggest "swing style" check valves which have low mass and will limit case drain spikes.
6. Fill the reservoir with fluid recommended for your application (see chart).

System Start-Up Procedures

Start-Up Instructions

1. Rotate the shaft by hand in the direction of the arrow on the pump body to insure freedom of rotation.
2. To prime the pump on initial start-up, it is imperative to clear all air from the pumping chambers. To do this, open center valving should be immediately downstream of the pump outlet port, which allows all flow (fluid and air) to pass directly to the tank upon start-up. If open center valving is not included in your circuit, position your valving so as to move cylinders and/or motors in a no-load condition (75-150 psi or 5-10 bar) until the pump has primed. This "no-load condition" value is not a pump compensating value, but is strictly the result of system resistance.
 - Another way to clear air from the pumping chamber and allow the pump to prime is to incorporate an automatic air bleed valve on the pump discharge port, or as close to the discharge port as possible. This valve will automatically open to allow air to exit back to the tank upon start-up. Once all air contained in the pump has been purged, the valve automatically closes.
3. If your pump incorporates the optional screw volume control, Continental Hydraulics recommends not reducing the pump's output flow by more than 50% on start-up (pump flow is reduced by turning the adjustment screw clockwise).
4. Jog the motor (no more than ten (10) revolutions if possible) and observe the direction of rotation. If the pump shaft is not rotating in the correct direction as the arrow on the pump body indicates, reverse the direction of rotation of the motor.
 - If rotation is correct, continue jogging the electric motor until the pump is primed. You will notice a definite pump tone change as well as pressure gauge movement when the pump begins to prime. Once the pump has primed, pressure adjustments can be made.
5. Pressure adjustments must be made against a blocked or deadhead system (cylinders and/or motors stalled or valving shut off). Increase the pressure by turning the pressure adjustment clockwise; counterclockwise to decrease it. The pump pressure setting should be as low as possible, yet high enough to insure satisfactory machine performance.
6. Continental recommends installing a low resistance check valve to prevent pump reversal on system shutdown.

Trouble Shooting

Some of the most common difficulties that could be experienced in the field are listed here with potential causes and their remedies.

TROUBLE	POTENTIAL CAUSE	REMEDY
Excessive pump noise	1) Coupling misalignment	Align the pump and motor shaft to within .006 inch (.152 mm) total indicator reading. The tighter the alignment, the quieter the pump will be.
	2) The continuous system pressure is significantly above or below the rated pressure of the pump.	Decrease system pressure to the pump rated pressure or adjust adjust the pump thrust screw to match system requirements.
	3) Fluid in the reservoir is low and the pump is sucking air.	Fill the reservoir so that the fluid level is well above the end of the suction line during all of the working cycle.
	4) Restricted inlet.	If a suction strainer is used, check it for obstructions or dirt. It is not recommended the use of strainers as they tend to be a leading cause of cavitation which manifests as excessive noise. Check also for shop rags left in the reservoir.
	5) Air leak in the suction line.	Tighten all fittings. If it still leaks, smear grease over the joints to locate the leak.
	6) Suction line has too many elbows, or is too long.	The suction line should be as short and as straight as possible reduce the resistance to flow.
	7) Air in the fluid.	The return line should terminate below the fluid level to prevent splashing.
	8) Suction line is too small.	Suction line should always be equal in size to the suction port. Never reduce it.
	9) Vane does not move freely.	Contamination in the fluid or a burr in the vane slot can cause a vane to bind up. Proper filtration and/or deburring of the vane slots is required.
	10) Vane is installed incorrectly.	Vanes must be mounted with the rounded edge toward the ring and toward the pump direction of rotation.
	11) A vane is missing.	Make sure all vane slots have a vane in them.
	12) Port plates installed incorrectly.	Plates must be installed so that the arrows point in the same direction as the rotational arrows on the pump body.
	13) Wrong direction of pump rotation.	Change the motor rotation.
	14) Low oil level.	Fill the reservoir so that the fluid level is well above the end of the suction line during all of the working cycle.
	15) Wrong type of oil.	Use a premium, clean hydraulic oil having the viscosity recommended for your application.
	16) Reservoir not vented.	Vent reservoir through the air filter to allow breathing action for fluctuating oil level.
	17) Slip line (case drain) does not terminate below oil level.	Extend case drain piping so that it terminates below the oil surface when oil is at its lowest level during any one machine cycle.
	18) Worn pressure ring.	Caused by hot, dirty, thin oil or no oil at all. Replace the pressure ring.
	19) Two pumps to a common manifold.	A check valve must be placed in the discharge line of both pumps to prevent back flow and surging. This check valve must also be present if an accumulator is in the discharge line.
Pump will not prime	1) Shaft rotation in the wrong direction.	When installing a pump, always jog the electric motor to check for proper shaft rotation. Rotation should only be clockwise (right hand) for PVX pumps.
	2) Air leak in the suction line.	Make sure all fittings are tight.
	3) Pump is air bound.	Use an air bleed valve to void the pump and suction line of air.
	4) Fluid level in the reservoir is too low.	Fill the reservoir so that the fluid level is well above the end of the suction line.
	5) Stroke limiter is turned in too far.	Flow should not be reduced more than 50% of maximum. Turn CW to restrict flow (see chart, page 41).
	6) Suction port dust plug left in place.	Remove plug.

Trouble Shooting (continued)

TROUBLE	POTENTIAL CAUSE	REMEDY
Pump is unstable	1) Contamination in the compensator.	Thoroughly clean the control orifices and check filtration.
	2) Pressure ring is not moving properly.	Control piston should be checked for freedom of movement.
System is too hot	1) Case drain line is installed too close to the pump inlet line.	The case drain and pump inlet should be separated by a baffle in the reservoir.
	2) Reservoir is undersized. Rule of thumb is a minimum of 2 to 3 times pump output flow.	Add a cooler.
	3) Pump operated at higher pressures than required.	Reduce pump pressure to the minimum required for installation.
	4) Pump discharging through relief valve.	Remove the relief valve. Relief valves are not required with Continental pumps having a spring or hydraulic pressure compensator governor (these valves create additional heat).
	5) Excessive system leakage through cylinders or valves.	Check progressively through the system for excessive leakage.
	6) High ambient or radiant temperature.	Relocate the power unit or baffle against radiant heat.
	7) Low oil in reservoir.	Bring the oil level up to recommended point.
	8) Excessive friction.	Make sure fluid is of proper viscosity.
	9) Reservoir too small.	Increase the size or install auxiliary cooling equipment.
	10) Restricted or undersize valves on hydraulic lines.	Clean valves and piping. Use adequate pipe sizes.
Leakage at oil seal	1) Abrasives on pump shaft.	Protect shaft from abrasive dust and foreign material.
	2) Scratched or damaged shaft seal.	Replace the oil seal assembly.
	3) Coupling misalignment.	Realign the pump and motor shafts. Align within 0.006 inch (0.152 mm) of the total indicator reading.
	4) Pressure in pump case.	Inspect case drain line for restrictions. Should be full pipe size direct to the reservoir. PVX-20 thru 75 pumps, the case drain has a check valve as standard equipment. Check for possible failure.
	5) Oil is too hot.	See <i>Trouble Shooting</i> section "System is too hot".
Bearing failure	1) Chips or other foreign material in bearings.	Make sure only clean oil is used. It is essential for efficient operation and long life of the bearings.
	2) Coupling misalignment.	Realign the pump and motor shafts. Align within 0.006 inch (0.152 mm) of the total indicator reading.
	3) System excessively hot.	See <i>Trouble Shooting</i> section "System is too hot".
	4) Electric motor shaft end play or driving/hammering on or off the pump shaft.	Continental pumps are not designed to handle end thrusts against the drive shaft. Eliminate all end play on electric motors. Couplings should be a slip fit onto the pump shaft.
	5) Incorrect fluid.	See fluid recommendations.
Pump not delivering oil	1) Adjusting screw for pressure adjustment too loose.	Tighten adjustment screw three (3) to five (5) turns after spring tension is felt.
	2) Wrong direction of pump rotation.	Change the motor rotation.
	3) Oil level low in reservoir.	Fill the reservoir so that the fluid level is well above the bottom of the suction line.
	4) Air leak in suction line. with the hydraulic fluid.	Tighten joints and apply good pipe compound that is compatible with the hydraulic fluid.
	5) Oil viscosity too heavy for proper priming.	Thinner oil should be used per recommendations for given temperatures and service.
	6) Maximum volume control turned in too far.	Turn counterclockwise on volume control adjusting screw to increase delivery.
	7) Bleed-off in other portion of circuit.	Check for open center valves or other controls connected with a tank port.
	8) Pump is not tuned correctly.	Recalibrate pump (see calibration procedures).
	9) Pump cover too loose.	Tighten bolts on the pump cover.

Trouble Shooting (continued)

TROUBLE	POTENTIAL CAUSE	REMEDY
<i>Pump not maintaining pressure</i>	1) Pump not delivering oil.	See <i>Trouble Shooting</i> section "Pump not delivering oil".
	2) Pressure adjustment screw not set high enough.	Set adjusting screw to obtain desired operating pressure.
	3) Compensator is in bad condition.	Replace the compensator.
	4) Vane or vanes stuck in rotor slots.	Inspect for wedged chips or sticky oil. Clean slots or replace oil.
	5) Oil is bypassing to reservoir.	Watch for open center valves or other valves open to the reservoir. Make sure that the relief valve settings are properly set high enough above the operating pressure in the system.
	6) Thrust screw not set properly.	Reset the thrust screw.

Dimensions of Double Pumps

Dimension Drawing

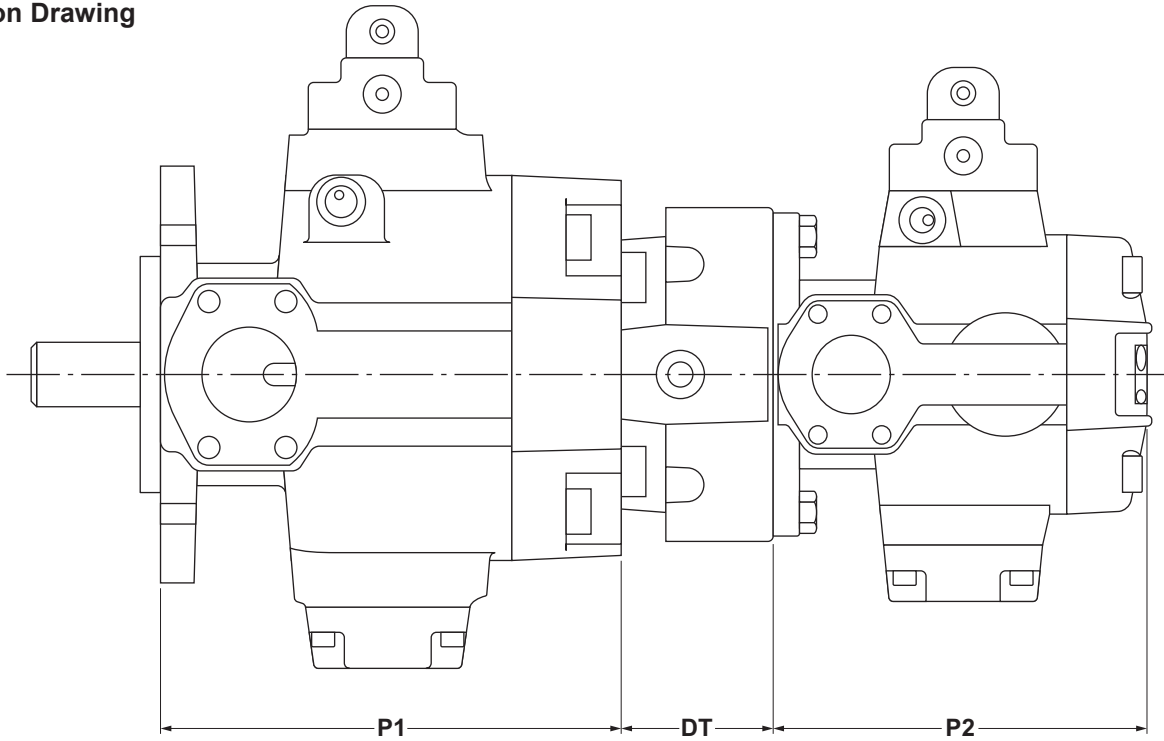

Possible Size Combinations	Pump 1 (P1) Inches (mm)	Adapter (DT) Inches (mm)	Pump 2 (P2) Inches (mm)
PVX-8 + PVX-8	6.10 (154.9)	1.95 (49.5)	6.05 (153.7)
PVX-11/15 + PVX-8	6.94 (176.3)	1.95 (49.5)	6.05 (153.7)
PVX-11/15 + PVX-11/15	6.94 (176.3)	2.55 (64.8)	7.05 (179.1)
PVX-20/29/36 + PVX-8	9.64 (244.9)	2.60 (66.0)	6.05 (153.7)
PVX-20/29/36 + PVX-11/15	9.64 (244.9)	3.59 (91.2)	7.05 (179.1)
PVX-20/29/36 + PVX-20/29/36	9.64 (244.9)	3.80 (96.5)	9.74 (247.4)
PVX-45/60/75 + PVX-8	12.00 (304.8)	2.61 (66.3)	6.05 (153.7)
PVX-45/60/75 + PVX-11/15	12.00 (304.8)	3.19 (81.0)	7.05 (179.1)
PVX-45/60/75 + PVX-20/29/36	12.00 (304.8)	3.80 (96.5)	9.74 (247.4)
PVX-45/60/75 + PVX-45/60/75	12.00 (304.8)	4.83 (122.7)	11.53 (292.9)



Continental Hydraulics
 5505 West 123rd St.
 Savage, MN 55378
 Phone: (952) 895-6400 Fax: (952) 895-6444
www.continentalhydraulics.com

Because Continental Hydraulics is continually improving its' products, specifications and appearance are subject to change without notice.