



Proportional Valve with On Board Electronics and Digital Interface

Start-up manual



Index

GENERAL INFO	4
Contacts	4
Led description	5
EBC configurator software	6
PARAMETERS	7
Summary	7
Configuration	8
SIGNAL_OFFSET	8
SIGNAL_GAIN	8
SIGNAL_TYPE	8
RAMPS	9
Output signals	10
CURVE ADJUSTMENT	10
PROCESS DATA (monitoring)	11
DIAGNOSTIC	11
APPENDIX 1: I/O Link Communication Interface	12
Reference	12
Parameter Description	12
Process Data Input PDI	12
Process Data Output PDO	14
Variables	15
APPENDIX 2: CANOPEN COMMUNICATION INTERFACE	18
Reference	18
Addresses and Baud Rate	18
Process Data Object	18
PDO TX	19
PDO RX	20
SDO	21
APPENDIX 3: PROFINET COMMUNICATION INTERFACE	24
Reference	24
Profinet installation guide	24
Profinet assignment	24
Device Data File (GSDML)	25
Cyclic Data - Process IO data exchange	25
APPENDIX 4: PROFIBUS COMMUNICATION INTERFACE	29
Reference	29
Installation	29
Device Data File (GSD)	29
Cyclic Data - Process IO data exchange	29
APPENDIX 5: ETHERCAT COMMUNICATION INTERFACE	33
Reference	33
EtherCAT installation guide	33
Device Data File (XML)	33
Cyclic Data - Process IO data exchange	33
TxPDO	33
RxPDO	35
APPENDIX 6: ETHERNET/IP COMMUNICATION INTERFACE	36
Reference	36

Device Data File (EDS).....	36
Producing Assembly	36
Consuming Assembly.....	39
Led Description.....	41

GENERAL INFO

This manual contains information about programming parameters with LinBus connection. Depending on the valve configuration, different programming tools should be used:

- VEA-PB7-D for analog valves
- VEA-PBL-A for IO-Link version (typically communication will be performed via the IO-Link Master)
- VEA-PB12-A for fieldbus communication valves

Appendix contains information about IO-Link interface.

This document is valid for proportional valves with on board electronics.

Should you have any questions concerning valves, please contact Continental Hydraulics or Duplomatic MS S.p.A., indicating the description, code and the serial number written on the label on case side.

Please refer to the VEA-PB* ID manual and EBC Config manual.

For installation, start-up, commissioning and maintenance use only skilled workers and materials fit for purpose, as recommended.

Before installation read this file and follow strictly what is indicated.

Continental Hydraulics and Duplomatic MS disclaims any liability for damage to person or property resulting from noncompliance of rules and instructions here declared, from misuse or incorrect use or from tampering of provided valves.

Contacts

Continental Hydraulics Inc.
4895 12th Avenue East
Shakopee Minn 55379
USA
tel. number: 952 895-6400
e-mail: sales@conthyd.com
www.continentalhydraulics.com

Duplomatic MS S.p.A.
via Mario Re Depaolini 24
I-20015 Parabiago (MI)
ITALY
tel. number: +39 0331.895.111
fax number: +39 0331.895.249
e-mail: support@duplomatic.com
<http://www.duplomatic.com>

Led description

Boards with IO Link interface are equipped with two leds **L1** and **L2**:

L1

- **Green blinking:** communication established with master device
- **Red blinking:** communication link broken

L2

- **Green solid:** valve running
- **Green blinking:** valve stopped by the user
- **Red blinking:** valve stopped because of an error, resuming allowed
- **Red solid:** valve stopped, critical error (board reset needed)

EBC configurator software

This is the software for OBE valves configuration.

EBC software is a graphical interface for digital communication, diagnostic tasks and parameterization.

It offers advanced diagnostic programs and an oscilloscope with measure functions, and allows to save and import parameters sets. This is useful for fast card replacement and for the reduction of start-up time of the system.

The software is available for download at:

http://www.duplomatic.com/en_US/download/software-download/

https://continentalhydraulics.com/product_items/motion-control-2/#515-516-ebc/

System Requirements & Settings

The EBC software can be installed on every machine equipped with Microsoft OS: Windows 7, 8 and 10, a free USB port to connect the communication cable (standard cable type USB A – micro USB B).

Launch the setup file and follow the guided procedure to install the program and USB drivers. Complete driver setup and restart the machine if requested before connecting the module to the PC.

At the end of installation, a security alert could appear, asking to define permissions for firewall, depending on your OS and notebook configuration.

See software literature (inside software pack) for EBC configuration software.



**We strongly recommend checking for last software version on our website.
New features may not be visible if you use older software versions.**

PARAMETERS

At software launch, the parameters are displayed in read only mode.

Parameter configuration is structured with different access levels.

To access “User” parameter config in the EBC software you need to log in with the following case-sensitive credentials:

Login: **User** Pwd: **Dol125**



Figure 1 -Password ICON

All displayed but **not changeable** parameters will be marked as **RO (Read Only)**

Summary

Parameter	Default value	Range	User level
SIGNAL_TYPE	According with ordered code	0...10V 4...20mA (1 solenoid valve) +/-10V 4...12...20mA (1 solenoid valve or DX valves)	User
SIGNAL_OFFSET	0.00	-3.000...+3.000 V -4.000...+4.000mA Unit according with signal type	User
SIGNAL_GAIN	1.000	0.400...10.000	User
RAMP_UP	0	0 – 20000 ms	User
RAMP_DOWN	0		
RAMP_UP_A	0	0 – 20000 ms	User
RAMP_DOWN_A	0		
RAMP_UP_B	0		
RAMP_DOWN_B	0		
ADJ_MIN	According with version	0 – 50%	User
ADJ_MAX	100%	ADJ_MIN – 120%	
ADJ_TRIGGER	1.5%	0 – 20%	
ADJ_MIN_A	According with version	0 – 50%	User
ADJ_MAX_A	100%	ADJ_MIN_A – 120%	
ADJ_TRIGGER	1.5%	0 – 20%	

ADJ_MIN_B	According with version	ADJ_MIN_B – 120%	
ADJ_MAX_B	100%	0 – 50%	

ADJ_MIN, ADJ_MAX parameters can be displayed in both absolute (mA) and percentage unit. This option can be set by the proper check box in the configuration software.

ADJ_TRIGGER can be displayed in absolute unit only (mA).

Configuration

SIGNAL_OFFSET

Command	Parameters	Unit	User Level/Group	Default
SIGNAL_OFFSET	-3.000/+3.000 -4.000/4.000	V mA	User	0.00
SIGNAL1_OFFSET SIGNAL2_OFFSET	-3.000/+3.000 -4.000/4.000	V mA	User	1.000

SIGNAL_GAIN

Command	Parameters	Unit	User Level/Group	Default
SIGNAL_GAIN	0.400-10.00	-	User	0.00

SIGNAL_TYPE

Command	Parameters	Unit	User Level/Group	Default
SIGNAL_TYPE	E0: 0...10 (1 solenoid valves) E1: 4...20 (2 solenoids valves) E0: ±10 (1 solenoid valves or DX) E1: 4...12...20 (2 solenoids valves or DX) USR: ±10 (2 solenoids valves or DX) USR: ±20 (2 solenoids valves or DX)	V mA V mA V mA	User	According with ordered code

Signal scaling example:

With valve the available signal type is -10...0...+10V.

If application signal is 0...2.5...5V this means:

- 0% signal for the valve must be moved from 2.5V (application 0%) to 0 V -> $\text{SIGNAL_OFFSET} = \text{Standard Offset} - \text{Application Offset} = 0 - 2.5 = -2.5 \text{ V}$
- Signal input must be scaled from 2.5V to Standard Full Scale of 10V -> $\text{SIGNAL_GAIN} = \text{Standard F.S.} / \text{Application F.S.} = 10 / 2.5 = 4.0$

RAMPS

Command	Parameters	Unit	User Level/Group	Default
RAMP_UP RAMP_DOWN	0-20000	ms	User	0
RAMP_UP_A RAMP_DOWN_A RAMP_UP_B RAMP_DOWN_B	0-20000	ms	User	0

Entered ramp time is related to 100% of signal variation.

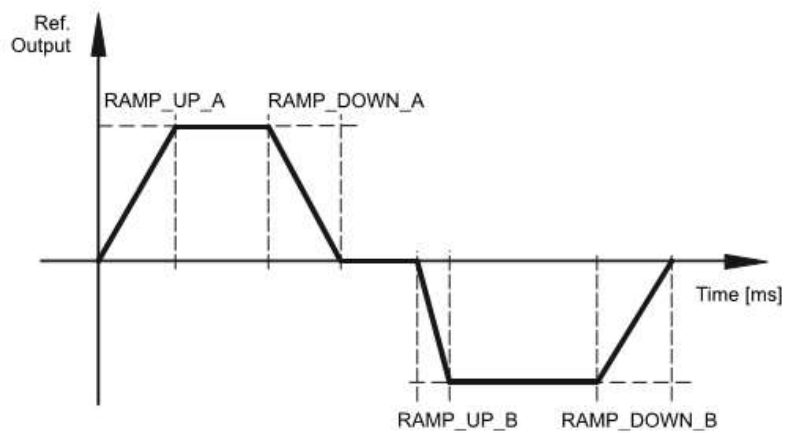

Output signals

CURVE ADJUSTMENT

Command	Parameters	Unit	User Level/Group	Default
ADJ_MIN ADJ_MAX ADJ_TRIGGER	0-50 ADJ_MIN – 120 0-20	%	User	0 100 1.5
ADJ_MIN_A ADJ_MAX_A ADJ_TRIGGER ADJ_MIN_B ADJ_MAX_B	0-50 ADJ_MIN_A – 120 0-20 0-50 ADJ_MIN_B – 120	%	User	0 100 1.5 0 100

With these commands, the **output signal is adjusted to the valve characteristics.**

The unit is percentage of nominal current (defined by CURRENT parameter).

The output signal (the maximum valve current) will be defined with the 'MAX' value. The overlap (dead band of the valve) will be compensated with the 'MIN' value. Via the TRIGGER the activation point of the MIN function is set and so a non-sensitive range around the zero-point can be specified.

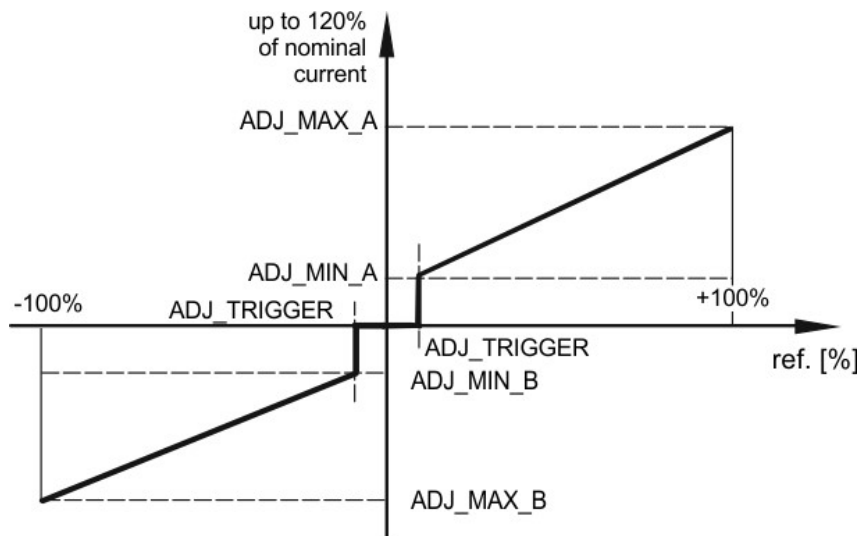

PROCESS DATA (monitoring)

The process data are the variables which can be continuously observed on the monitor or on the oscilloscope.

Command	Description	Unit
SIGNAL	Command value after input scaling	mA - V %
CURRENT CURRENT_A CURRENT_B	Output current of solenoid Output current of solenoid A (CH1) Output current of solenoid B (CH2)	mA
CURRENT_ERR CURRENT_ERR_A CURRENT_ERR_B	Current error solenoid CH1 Current error solenoid A (CH1) Current error solenoid B (CH2)	%
LVDT_ERR	Error of the position or pressure transducer	%
TEMP_BOARD	Temperature of the board	°C
TEMP_PWRSTG	Temperature of the power stage of the board	°C
V_CTRL	Supply voltage	V
V_PWRSTG	Power stage voltage	V

DIAGNOSTIC

Valve error detection should be performed using configurator through the error message.

A list of the error messages appears as showed in the picture below.

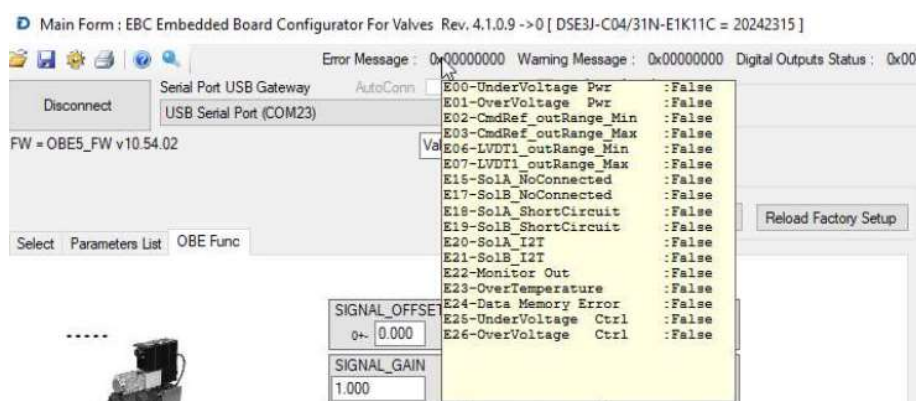

For E1 valves with output monitor function on pin F, in case of error detected, the output current value is set to a value lower than 3 mA (this is valid if valve is not connected with LinPC).

APPENDIX 1: I/O Link Communication Interface

This appendix is valid for the following products:

- PROPORTIONAL directional control valves
- PROPORTIONAL pressure control valves

The parametrization of the valve should be done using the Master IO-Link tool according to the IO-Link specification. Typical Master IO-link devices are power strip, remote or main PLC.

Reference

IEC 61131-9 Programmable controllers - Part 9: Single-drop digital communication interface for small sensors and actuators (SDCI)

Parameter Description

Process Data Input PDI

Process Data Input PDI are sent from valve to process Master IO-link devices through Fieldbus.

Total Process Data Input length is 4 octets (32 Bits) according to table below:

Bit Offset	Bit Length	Name				Data Type	Value Range	Description
		No Feedback		with Feedback				
		1- sol	2-sol	1-sol	2-sol			
0	1	Coil a state	Coil a state	Coil a state	Coil a state	BooleanT	0 = Disabled 1 = Enabled	
1	1	-	Coil b state	-	Coil b state	BooleanT	0 = Disabled 1 = Enabled	
4	1	Monitor a	Monitor a	Monitor a	Monitor a	BooleanT	--	Reserved for future use
5	1	-	Monitor b	-	Monitor b	BooleanT	--	Reserved for future use
8	1	Error a	Error a	Error a	Error a	BooleanT	0 = No Error 1 = Error	When error is executed it throws an exception that must be investigate
9	1	-	Error b	-	Error b	BooleanT	0 = No Error 1 = Error	When error is executed it throws an exception that must be investigate
10	2	Mode	Mode	Mode	Mode	UIntegerT	--	Reserved for future use
12	1	Monitor a Not	Monitor a Not	Monitor a Not	Monitor a Not	BooleanT	--	Reserved for future use
13	1	-	Monitor b Not	-	Monitor b Not	BooleanT	--	Reserved for future use
14	1	Warning a	Warning a	Warning a	Warning a	BooleanT	0 = No Warning 1 = Warning	Warning just give an alert, the valve follow run.
15	1	-	Warning b	-	Warning b	BooleanT	0 = No Warning 1 = Warning	Warning just give an alert, the valve follow run.
16	16	Monitor	Monitor	Monitor	Monitor	UIntegerT	-10000, +10000	Expressed in 0.01%

Process Data Output PDO

Total Process Data Input length is 4 octets (32 bits) according to table below:

Offset	Bit Length	Name				Data Type	Value Range	Description
		No Feedback		With Feedback				
		1 - sol	2 - sol	1 - sol	2 - sol			
0	1	Coil a Command	Coil a Command	Coil a Command	Coil a Command	BooleanT	0 = Enable 1 = Disable	Command to the valve is executed
1	1	-	Coil b Command	-	Coil b Command	BooleanT	0 = Enable 1 = Disable	Command to the valve is executed
2	1	Clear Error a	Clear Error a	Clear Error a	Clear Error a	BooleanT	0 = No action 1= Clear error	Acknowledgment of the error. If the error still appears it cannot be cleared.
3	1	-	Clear Error b	-	Clear Error b	BooleanT	0 = No action 1= Clear error	Acknowledgment of the error. If the error still appears it cannot be cleared.
16	16	Reference command for valve	Reference command for valve	Reference command for valve	Reference command for valve	IntegerT	-10000, 10000	The reference command to valve. Expressed in 0.01 %

Variables

Variable Names (i)	Alias	Menu	Index	Length	Access Policy	Description	Value range (min,max) and Default value	1-solenoid no Feedback	2-solenoid no Feedback	1 solenoid with Feedback	2-solenoid with Feedback
Requests Flags	-	Parameter/Configuration	80	16	rw	Bitfield, can be written to request some tasks: bit0 = 1 (TOGGLE ↑) -> Update configuration bit1 = 1 (TOGGLE ↑) -> Save configuration to EEprom		X	X	X	X
R_MaxP	ADJ_MAX_A	Parameter/Configuration	81	16	rw DATA STORAGE	Reference 1 Max positive [0, 100%] Unit 0,01%	0, 10000 Default 10000	X	X	X	X
R_MinP	ADJ_MIN_A	Parameter/Configuration	82	16	rw DATA STORAGE	Reference 1 Min positive [0, 100%]	0, 10000 Default 0	X	X	X	X
R_Trigger	ADJ_TRIGGER	Parameter/Configuration	83	16	rw DATA STORAGE	Reference 1 Trigger [0, 100%]	0, 10000 Default 150	X	X	X	X
R_MinN	ADJ_MIN_B	Parameter/Configuration	84	16	rw DATA STORAGE	Reference 1 Min negative [0, 100%]	0, 10000 Default 0	--	X	--	X
R_MaxN	ADJ_MAX_B	Parameter/Configuration	85	16	rw DATA STORAGE	Reference 1 Max negative [0, 100%]	0, 10000 Default 10000	--	X	--	X
R_RupP	RAMP_UP_A	Parameter/Configuration	86	16	rw DATA STORAGE	Time [ms] for 0 to 100% sweep	0, 20000 Default 0	X	X	X	X
R_RdwP	RAMP_DOWN_A	Parameter/Configuration	87	16	rw DATA STORAGE	Time [ms] for 100% to 0% sweep	0, 20000 Default 0	X	X	X	X
R_RupN	RAMP_UP_B	Parameter/Configuration	88	16	rw DATA STORAGE	Time [ms]	0, 20000 Default 0	X	X	X	X
R_RdwN	RAMP_DOWN_B	Parameter/Configuration	89	16	rw DATA STORAGE	Time [ms]	0, 20000 Default 0	--	X	--	X
Current temperature	TEMPERATURE	Diagnosis	90	16	ro	H-Bridge (power stage) temperature [0.1°C]	-60, 150 --	X	X	X	X
Minimum temperature	-	Diagnosis	191	16	ro	Min Temperature measured [0.1°C]	-60, 150 --	X	X	X	X
Maximum temperature	-	Diagnosis	192	16	ro	Max Temperature measured [0.1°C]	-60, 150 --	X	X	X	X
Control Stage Voltage	_24VCtrl	Diagnosis	91	16	ro	Control stage power supply voltage [mVolt]	0, 50 --	X	X	X	X
Power Stage Voltage	_24VPrw	Diagnosis	92	16	ro	Power stage power supply voltage [mVolt]	0, 50 --	X	X	X	X
Sol1 Current	CURRENTa	Diagnosis	93	16	ro	Solenoid a current (mA)	-2, 7000 --	X	X	X	X
Sol2 Current	CURRENTb	Diagnosis	94	16	ro	Solenoid b current (mA)	-2, 7000 --	--	X	--	X

Hours powered	HOURS_POWERED	Diagnosis	100	32	ro	Totally hours powered of valve [h]	0, 10000000 Default 0	X	X	X	X
Hours Sol1 On	HOURS_SOLa_ON	Diagnosis	101	32	ro	Totally hours powered of solenoid a [h][sec]	0, 10000000 Default 0	X	X	X	X
Hours Sol2 On	HOURS_SOLb_ON	Diagnosis	102	32	ro	Totally hours powered of solenoid b [h]	0, 10000000 Default 0	--	X	--	X
Errors	-	Diagnosis	200	32	ro	Errors – see table		X	X	X	X
Warnings	-	Diagnosis	201	32	ro	Warnings – see table		X	X	X	X

Note (i)

Variables, indicate as rw, can be modified by Master IOLINK and become operative only after requesting a configuration update through the 'RequestFlags' register (bit0 = 1 (TOGGLE ↑ on rising edge)). In order to avoid the loss of data changed on the valve, for example at power-off, it is necessary to make a save to EEprom through the 'RequestFlags' register (bit1 = 1 (TOGGLE ↑ on rising edge)). At power-on the Master IO-Link store data indicate as "data storage" to the valve; in this mode the device change, accordingly to specification IOLINK V1.1 is supported because the parameterization can be implemented automatically by Master IO-Link.

Solenoid "a" and Solenoid "b" are referred to the following figure.

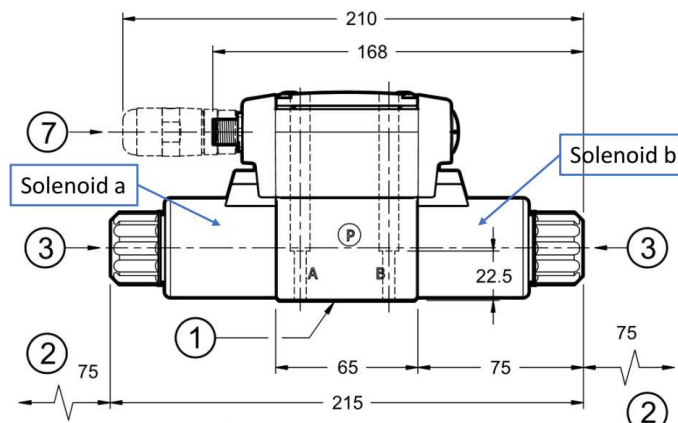

For 1-solenoid valves, solenoid "a" refer to the only solenoid available, independently if valve is type SA or SB. For 2-solenoids valve, the hydraulic function is according to the Spool Type, check catalogue for further details:

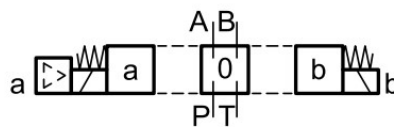

Errors		
LSB	0	Undervoltage of the power stage - Hbridges
	1	Overtoltage of the power stage - Hbridges
	2	Command Reference 0 - Out of range minimum
	3	Command Reference 0 - Out of range maximum
	4	Command Reference 1 - Out of range minimum
	5	Command Reference 1 - Out of range maximum
	6	Feedback 0 - Out of range minimum
	7	Feedback 0 - Out of range maximum
	8	Feedback 1 - Out of range minimum
	9	Feedback 1 - Out of range maximum
	10	-
	11	-
	12	-
	13	-
	14	-
	15	-
	16	solenoid not connected - channel 1
	17	solenoid not connected - channel 2
	18	short circuit - channel 1
	19	short circuit - channel 2
	20	I2T error sol. 1
	21	I2T error sol. 2
	22	-
	23	uP OverTemperature Error
	24	HBridge OverTemperature Error
		-
MSB	31	-

APPENDIX 2: CANOPEN COMMUNICATION INTERFACE

This appendix is valid for the following products:

- PROPORTIONAL directional control valves
- PROPORTIONAL pressure control valves

Reference

CiA 301 CANOPEN application layer and communication profile

CiA 408 Device profile fluid power technology proportional valves and hydrostatic transmissions

Addresses and Baud Rate

The addresses can be programmed by mean of an SDO, the default Address is 1; it is also possible to modify address by EbcCfg.

The Baud rate can be programmed by mean of an SDO, the default Address is 125; it is also possible to modify Baud rate by EbcCfg.

Process Data Object

The default COB-ID for the first PDO is 0x180+Node ID, the default COB-ID for the first receive PDO is 0x200+Node ID. Changing of the COB-ID is possible by access at object directory Index 1800 and 1400 respectively.

PDO TX

The transmit PDO (PDO 0 TX) has a COB-ID = 0x180 + node number. The structure of the PDO is according to the table below:

Byte Offset	Length	Name	Value Range	Description
0	2	Status Word	See table below	-
1				
2	2	Valve Position	From -10000 (0xD8F0) to 10000 (0x2710)	Command value equals to -200% to 200%
3				
4	2	-	-	Not Implemented
5				

Status Word		
LSB	0	Disabled
	1	Hold enable
	2	Device Mode ON
	3	Ready
	4	Local Control
	5	Warning
	6	Reserved
	7	
	8	
	9	Ramp Running
	10	Reserved
	11	
	12	Actual value Reached Target Window
	13	Reserved
	14	
MSB	15	

PDO RX

The receive PDO (PDO 0 RX) has a COB-ID = 0x200 + node number. The structure of the PDO is according to the table below:

Byte Offset	Length	Name	Value Range	Description
0	2	Control Word	See table below	
1				
2	2	Command Value 1	From -10000 (0xD8F0) to 10000 (0x2710)	Command value equal to -200% to 200%
3				
4	2	-	-	Not Implemented
5				

Control Word		
LSB	0	Disabled
	1	Hold enable
	2	Device Mode ON
	3	Ready
	4	Local Control
	5	Reserved
	6	
	7	
	8	
	9	
	10	
	11	
	12	
	13	
	14	
MSB	15	

SDO

The Service Data Object provides the access to entries of a device Object Dictionary. The Object Dictionary is accordingly to CiA 408 Device profile fluid power technology proportional valves.

The parameters changed are saved automatically, the valve doesn't support the use of the object "store" (index 1010H) and "restore" (index 1011H).

As follow a description of the

Object	Data Type	Value	Meaning	Default Value	Index	Sub Index	Description
Error Message	Double word		See Table		4000	0	If at least one bit of the error message in true, the valve detects an error and is out of service.
Warning Message	Word		See Table		4002	0	A warning doesn't stop the function of the valve.
Digital Output Status	Word		See Table		4003	0	Digital output status array
Digital Input Status	Word		See Table		4004	0	Digital input status array
Valve Address		1-127		1	4200	0	Programmed valve Address
Baud Rate		0	1 MBaud/s	12	4201	0	Programmed Baud rate other values not supported
		5	500 KBaud/s				
		7	250 KBaud/s				
		9	125 KBaud/s				
		10	100 KBaud/s				
		11	50 KBaud/s				
		12	20 KBaud/s				
		13	10 KBaud/s				
Local control		0	Control word set by CAN-Open	0	604F	0	
		1	The valve use Analog Signals				
Ramp Up Positive		0-20000	Acceleration time 0%→100%	0	6332	1	[msec]
Ramp Down Positive		0-20000	Deceleration time 100%-->0%	0	6335	1	[msec]

Ramp Up Negative		0-20000	Acceleration time 0%→-100%	0	6333	1	[msec]
Ramp Down Negative		0-20000	Deceleration time -100% → 0%	0	6336	1	[msec]
Dead Band Activation		0	Dead Band off		6342	0	
		1	Dead Band on	1			
Adjust_Min_Positive					6343	1	Default value depend on valve type
Adjust_Min_Negative					6344	1	Default value depend on valve type
Trigger		0-10000	Dead Band Value	100	6345	1	Threshold value equal for positive or negative value
Adjust_Max_Positive				10000	To be defined	1	Default value 100%
Adjust_Max_Negative				10000	To be defined	1	Default value 100%

The Error Message, Warning Message, Digital Input Status and Digital Output Status Objects are useful for troubleshooting, as follow the detailed description list:

Errors		
LSB	0	Undervoltage of the power stage - Hbridges
	1	Overvoltage of the power stage - Hbridges
	2	Command Reference 0 - Out of range minimum
	3	Command Reference 0 - Out of range maximum
	4	Command Reference 1 - Out of range minimum
	5	Command Reference 1 - Out of range maximum
	6	Feedback 0 - Out of range minimum
	7	Feedback 0 - Out of range maximum
	8	Feedback 1 - Out of range minimum
	9	Feedback 1 - Out of range maximum
	10	-
	11	-

	12	-
	13	-
	14	-
	15	-
	16	solenoid not connected - channel 1
	17	solenoid not connected - channel 2
	18	short circuit - channel 1
	19	short circuit - channel 2
	20	I2T error sol. 1
	21	I2T error sol. 2
	22	-
	23	uP OverTemperature Error
	24	HBridge OverTemperature Error
		-
MSB	31	-

Object	Bit	Description
Digital input Status		Bridge_A1_Enable
		Bribge_A2_Enable
		Bridge_B1_Enable
		Bribge_B2_Enable
		InPos_Status

Object	Bit	Description
Digital output Status		Enable

APPENDIX 3: PROFINET COMMUNICATION INTERFACE

This appendix is valid for the following products:

- PROPORTIONAL directional control valves
- PROPORTIONAL pressure control valves

Reference

PROFINET is the standard for industrial ethernet based on IEEE 802.xx. PROFINET is based on the 100 Mb/s-version of full-duplex and switched Ethernet. PROFINET IO is designed for the fast data exchange between Ethernet-based controllers (master functionality) and field devices (slave functionality).

Hydraulic valves with PROFINET communication interface can be operated as device ("IO-device"). Reference according to the international standard IEC 61784-2, only CC-A class support.

Profinet installation guide

The ProfiNet IO field devices are connected exclusively via switches as network components. A ProfiNet IO network can be set up in star, tree, line or ring topology. ProfiNet IO is based on the Fast Ethernet standard transmission with 100 Mbit/s. The transmission media are copper cables CAT5.

For the IP20 environment in the control cabinet, the RJ45 connector CAT5 according to EN 50173 or ISO/IEC 11801 is used. The pin assignment is compatible with the Ethernet standard (ISO/IEC 8802-3).

The connection between ProfiNet participants is called ProfiNet Channel. In most cases, ProfiNet channels are built with copper cables to IEC 61784-5-3 and IEC 24702. The maximum length of a ProfiNet channel, which is constructed with copper cables, is 100 m.

Profinet assignment

All PROFINET IO slave devices need name and IP address to initiate communication.

Both are assigned to the device by the ProfiNet-IO-controller (PLC). The device name of the PROFINET IO device is stored in persistent memory in the device. It can be modified by a Profinet IO supervisor, e.g. the programming system of the belonging PLC.

Default:

Name:	
IP Address:	0.0.0.0
Subnet-Mask:	0.0.0.0
IP Address Gateway:	0.0.0.0

Example:

Name:	dms-valve
IP Address:	192.168.1.111
Subnet-Mask:	255.255.255.0
IP Address Gateway:	192.168.1.111

Device Data File (GSDML)

The characteristics of an IO device are described by the device manufacturer in a General Station Description (GSDML) file.

The language used for this purpose is the GSDML (GSD Markup Language) - an XML based language.

For I/O data, the .GSDML file describes the structure of the cyclic input and output data transferred between the Programmable Controller and the PROFINET IO device.

Any mismatch between the size or structure of the input and output data and the actual internal device structure generates an alarm to the device.

In the configuration of transmission data select 12 bytes for input and 12 bytes for output.

Cyclic Data - Process IO data exchange

The IO controller exchange data on each IO device in accordance with GSDML file. PDO consist of the following bytes:

Input from Fieldbus – 12 Byte

Byte	Function	Type	Bit Length	Unit
0..7	Reserved	Octet String	64	-
8-9	Control Word	Unsigned16	16	-
10-11	Control Reference	Signed16	16	-10000, +10000 expressed in 0.01%

Description of the Control Word

Bit Number	Name	Description	Type	Default
0	Disabled	This bit determines the device condition	Bool	0
1	Hold enable	This bit determines the device condition	Bool	0
2	Device Mode Active Enable	This bit determines the device condition	Bool	0
3	Reset fault	It is possible to reset faults, if not active	Bool	0
4	Reserved		Bool	0
5	Reserved		Bool	0
6	Reserved		Bool	0
7	Reserved		Bool	0
8	Reserved		Bool	0

9	Reserved		Bool	0
10	Reserved		Bool	0
11	Reserved		Bool	0
12	Reserved		Bool	0
13	Reserved		Bool	0
14	Reserved		Bool	0
15	Reserved		Bool	0

Data sent to Fieldbus – Byte12

Byte	Function	Type	Bit Length	
0..7	Reserved	Octet String	64	
8-9	Status Word	Unsigned16	16	
10-11	Monitor	Signed16	16	-10000, +10000 expressed in 0.01%

Description of the Status Word

Bit Number	Name	Description	Type	Default
0	Disabled	Device Condition	Bool	0
1	Hold enable	Device Condition	Bool	0
2	Device Mode active enable	Device Condition	Bool	0
3	Ready I	Device Condition	Bool	0
4	Local Control	= 1 The Control Word is given locally and the control word transmitted via bus is ignored = 0 Control word transmitted via bus is effective	Bool	0
5	Warning	= 1 Device warning = 0 No warning	Bool	0
6	Reserved		Bool	0
7	Reserved		Bool	0
8	Reserved		Bool	0
9	Reserved		Bool	0
10	Reserved		Bool	0

11	Reserved		Bool	0
12	Reserved		Bool	0
13	Reserved		Bool	0
14	Reserved		Bool	0
15	Reserved		Bool	0

The device state condition and device state transition of valve are in accordingly to Fluid Power Technology Profile (Order n°3112), follow figure shows the state machine diagram:

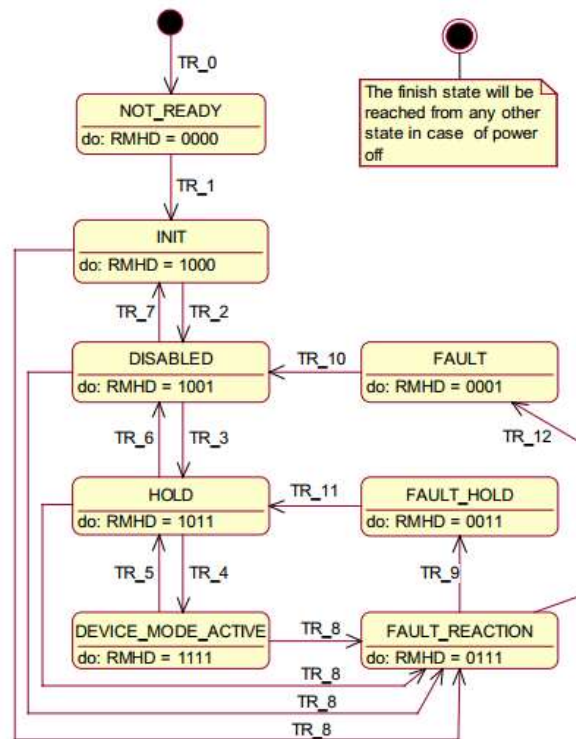

The state transitions according to table below:

Transition	Short description	Control Word bits							
		7	6	5	4	3	2	1	0
						R	M	H	D
Tr_0	Power-up								
Tr_1	Device init successful								
Tr_2	Activate Disable	X	X	X	X	X	X	X	1
Tr_3	Activate Hold	X	X	X	X	X	X	1	1
Tr_4	Activate Device mode	X	X	X	X	X	1	1	1
Tr_5	De-Activate Device mode	X	X	X	X	X	0	X	X
Tr_6	De-Activate Hold	X	X	X	X	X	0	0	X
Tr_7	Deactivate Disabled	X	X	X	X	X	0	0	0
Tr_8	Fault Detected								
Tr_9	Fault Reaction Successful								
Tr_10	Reset Fault (Disabled)	X	X	X	X	0	X	0	X
		→							
		X	X	X	X	1	X	0	X
Tr_11	Reset Fault (Hold)	X	X	X	X	0	X	1	X
		→							
		X	X	X	X	1	X	1	X
Tr_12	Fault Reaction Successful								

Example: in order to reach the Device Mode_Active condition, it is possible to send cyclically the control word x111. Three cycles after the device init successful, the valve will reach the DEVICE_MODE_ACTIVE, if there are no faults.

APPENDIX 4: PROFIBUS COMMUNICATION INTERFACE

This appendix is valid for the following products:

- PROPORTIONAL directional control valves
- PROPORTIONAL pressure control valves

Reference

The Profibus module supports all baud rates from 9,6 kbit/s up to 12000 kbit/s with auto detection of the baud rate, default value is 19,2 kBit/s; it is possible to change the baud rate by access device by software configurator Ebc Cfg. The functionality is defined in IEC 61158 and EN 50170.

Valve designed according to Fluid Power Technology Profibus Profile Order n. 3112.

Installation

A typical screened Profibus plug (D-Sub 9poles with switchable termination) is mandatory. Every Profibus segment must be provided with an active bus termination at the beginning and at the end. The termination is already integrated in all common Profibus plugs and can be activated by DIL switches. The bus termination needs a 5 Volt power supply for the current function, which is supplied at PIN 6 of the D-sub socket. The Profibus cable has to be screened at the determined contact clips in the Profibus plug.

Device Data File (GSD)

The Profibus-DP features are documented in a device-data file. Structure, content and code of this file (GSD) are standardized. They allow the projecting of any DP slaves with projecting device of several producers. The GSD files are read by a Profibus Master configuration software and the corresponding settings are given to the master. The GSD file is available at Duplomatic website.

In the configuration of transmission data select 12 bytes for input and 12 bytes for output.

Cyclic Data - Process IO data exchange

The IO controller exchange data on each IO device in accordance with GSD file.

PDO consist of the following bytes:

Input from Fieldbus – 12 Byte

Byte	Function	Type	Bit Lenght	Unit
0..7	Reserved	Octet String	64	-
8-9	Control Word	Unsigned16	16	-
10-11	Control Reference	Signed16	16	-10000, +10000 expressed in 0.01%

Description of the **Control Word**

Bit Number	Name	Description	Type	Default
0	Disabled	Device Condition	Bool	0
1	Hold enable	Device Condition	Bool	0
2	Device Mode Active Enable	Device Condition	Bool	0
3	Reset fault	It is possible to reset faults, if not active	Bool	0
4	Reserved		Bool	0
5	Reserved		Bool	0
6	Reserved		Bool	0
7	Reserved		Bool	0
8	Reserved		Bool	0
9	Reserved		Bool	0
10	Reserved		Bool	0
11	Reserved		Bool	0
12	Reserved		Bool	0
13	Reserved		Bool	0
14	Reserved		Bool	0
15	Reserved		Bool	0

Data sent to Fieldbus – Byte12

Byte	Function	Type	Bit Length	
0..7	Reserved	Octet String	64	
8-9	Status Word	Unsigned16	16	
10-11	Monitor	Signed16	16	-10000, +10000 expressed in 0.01%

Description of the Status Word

Bit Number	Name	Description	Type	Default
0	Disabled	Device Condition	Bool	0
1	Hold enable	Device Condition	Bool	0
2	Device Mode active enable	Device Condition	Bool	0
3	Ready I	Device Condition	Bool	0

4	Local Control	= 1 The Control Word is given locally and the control word transmitted via bus is ignored = 0 Control word transmitted via bus is effective	Bool	0
5	Warning	= 1 Device warning = 0 No warning	Bool	0
6	Reserved		Bool	0
7	Reserved		Bool	0
8	Reserved		Bool	0
9	Reserved		Bool	0
10	Reserved		Bool	0
11	Reserved		Bool	0
12	Reserved		Bool	0
13	Reserved		Bool	0
14	Reserved		Bool	0
15	Reserved		Bool	0

The device state condition and device state transition of valve are in accordingly to Fluid Power Technology Profile (Order n°3112), follow figure shows the state machine diagram:

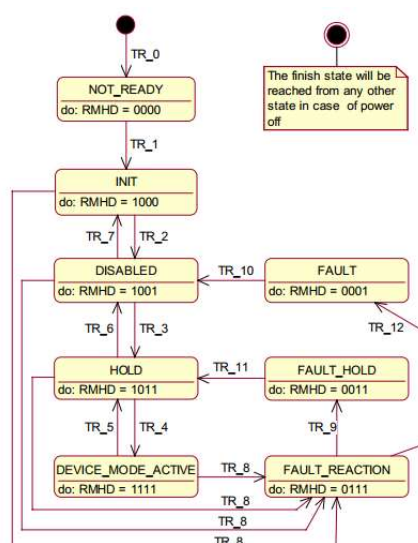

The state transitions according to table below:

Transition	Short description	Control Word bits							
		7	6	5	4	3	2	1	0
						R	M	H	D
Tr_0	Power-up								
Tr_1	Device init successful								
Tr_2	Activate Disable	X	X	X	X	X	X	X	1
Tr_3	Activate Hold	X	X	X	X	X	X	1	1
Tr_4	Activate Device mode	X	X	X	X	X	1	1	1
Tr_5	De-Activate Device mode	X	X	X	X	X	0	X	X
Tr_6	De-Activate Hold	X	X	X	X	X	0	0	X
Tr_7	Deactivate Disabled	X	X	X	X	X	0	0	0
Tr_8	Fault Detected								
Tr_9	Fault Reaction Successful								
Tr_10	Reset Fault (Disabled)	X	X	X	X	0	X	0	X
		→							
		X	X	X	X	1	X	0	X
Tr_11	Reset Fault (Hold)	X	X	X	X	0	X	1	X
		→							
		X	X	X	X	1	X	1	X
Tr_12	Fault Reaction Successful								

Example: in order to reach the Device Mode Active condition, it is possible to send cyclically the control word x111. Three cycles after the device init successful, the valve will reach the DEVICE_MODE_ACTIVE, if there are no faults.

APPENDIX 5: ETHERCAT COMMUNICATION INTERFACE

This appendix is valid for the following products:

- PROPORTIONAL directional control valves
- PROPORTIONAL pressure control valves

Reference

ETHERCAT (EtherNET for Control Automation Technology) is an EtherNET based fieldbus system, the standard based on IEC 61158, using full-duplex Ethernet physical layers.

EtherCAT installation guide

The EtherCAT network consists of one master and one or more slave devices. EtherCAT supports three different physical media, 100BASE-TX 100 Mbit/s full-duplex transmission on copper cable (up to 100 m distances), 100BASE-FX, 100 Mbit/s full-duplex transmission on fiber optics (up to several km distances) and LVDS, 100 Mbit/s full-duplex transmission on backplane connections. An EtherCAT network can be set up in star, tree, line or daisy chain topology.

Device Data File (XML)

The characteristics of an IO device are described by the device manufacturer in a ESI (EtherCAT Slave Information) file.

The language used for this purpose is the XML language. For I/O data, the XML file describes the structure of the cyclic input and output data transferred between the Programmable Controller and the EtherCAT IO device.

Any mismatch between the size or structure of the input and output data and the actual internal device structure generates an alarm to the device.

In the configuration of transmission data selects 8 bytes for input and 8 bytes for output.

Cyclic Data - Process IO data exchange

The IO controller exchange data on each IO device in accordance with XML file. Data from master to slave named TxPDO, data from slave to master named RxPDO. The Process Data Objects can be rPDO consist of the following bytes:

TxPDO

The structure of the PDO is according to the table below:

Byte Offset	Length	Name	Value Range	Description
0	2	Status Word	See table below	-
1				
2	2	Valve Position	From -10000 (0xD8F0) to 10000 (0x2710)	Command value equals to -200% to 200%
3				
4	4	Value SSI	Signed 32 bit	According to SSI data sheet
5				
6				
7				

Status Word		
LSB	0	Disabled
	1	Hold enable
	2	Device Mode ON
	3	Ready
	4	Local Control
	5	Warning
	6	Reserved
	7	
	8	
	9	Ramp Running
	10	Reserved
	11	
	12	Actual value Reached Target Window
	13	Reserved
	14	
MSB	15	

RxPDO

The structure of the PDO is according to the table below:

Byte Offset	Length	Name	Value Range	Description
0	2	Control Word	See table below	
1				
2	2	Command Value 1	From -10000 (0xD8F0) to 10000 (0x2710)	Command value equal to -200% to 200%
3				
4	4	-	-	Not Implemented
5				
6				
7				

Control Word		
LSB	0	Disabled
	1	Hold enable
	2	Device Mode ON
	3	Ready
	4	Local Control
	5	Reserved
	6	
	7	
	8	
	9	
	10	
	11	
	12	
	13	
	14	
MSB	15	

APPENDIX 6: ETHERNET/IP COMMUNICATION INTERFACE

This appendix is valid for the following products:

- PROPORTIONAL directional control valves
- PROPORTIONAL pressure control valves

Reference

Ethernet/IP is the name given to Common Industrial Protocol (CIP) as implemented over standard Ethernet (IEEE802.3 and the TCP/IP protocol suite). Hydraulic valves with Ethernet/IP communication interface can be operated as adapter and provides data to a scanner device (Implicit Message).

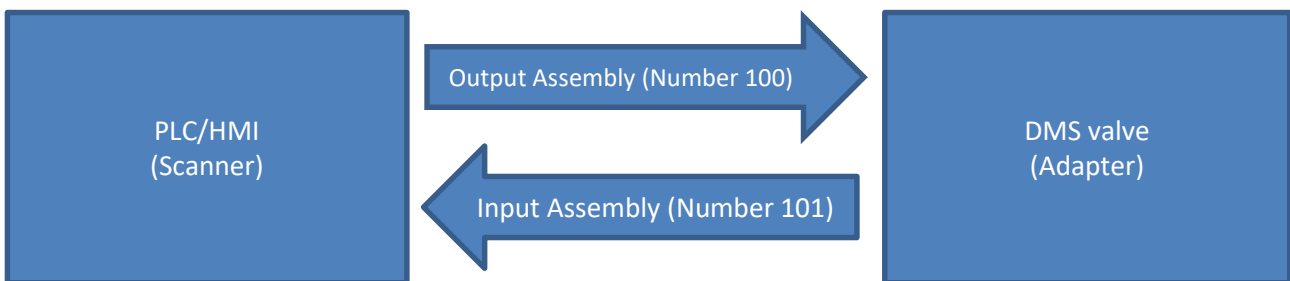

Device Data File (EDS)

The Ethernet-IP features are described in an Electronic Data Sheet, so called EDS files, it is an ASCII text file used by software tools for device and network connection configuration. The EDS file of valve provide the identity information required for a network tool to recognize the valve and specify the Input and Output Message produced and consumed by the Adapter.

Producing Assembly

Output Assembly according to table below (Assembly Number 100), size in byte 8

Byte	Function	Type	Bit Length	Unit
0-1	Status Word		16	-
2-3	Monitor		16	-10000, +10000 expressed in 0.01%
4-7	Error		32	-

Description of the **Status Word**

Bit Number	Name	Description	Type	Default
0	Disabled	Device Condition	Bool	0
1	Hold enable	Device Condition	Bool	0
2	Device Mode active enable	Device Condition	Bool	0
3	Ready I	Device Condition	Bool	0
4	Local Control	= 1 The Control Word is given locally and the control word transmitted via bus is ignored = 0 Control word transmitted via bus is effective	Bool	0
5	Warning	= 1 Device warning = 0 No warning	Bool	0
6	Reserved		Bool	0
7	Reserved		Bool	0
8	Reserved		Bool	0
9	Reserved		Bool	0
10	Reserved		Bool	0
11	Reserved		Bool	0
12	Reserved		Bool	0
13	Reserved		Bool	0
14	Reserved		Bool	0
15	Reserved		Bool	0

Description of the **Error Message**, if true the error is active, false no error.

Bit Number	Error Name	Description
0	UNDERVOLTTPWR	Undervoltage of the power stage - Hbridges
1	OVERVOLTCTPWR	Overvoltage of the power stage - Hbridges
2	OUTRANGEMINCMD0	Command Reference 0 - Out of range minimum
3	OUTRANGEMAXCMD0	Command Reference 0 - Out of range maximum
4	OUTRANGEMINCMD1	Command Reference 1 - Out of range minimum

5	OUTRANGEMAXCMD1	Command Reference 1 - Out of range maximum
6	OUTRANGEMINFBK0	Feedback 0 - Out of range minimum
7	OUTRANGEMAXFBK0	Feedback 0 - Out of range maximum
8	OUTRANGEMINFBK1	Feedback 1 - Out of range minimum
9	OUTRANGEMAXFBK1	Feedback 1 - Out of range maximum
10	-	-
11	-	-
12	-	-
13	-	-
14	-	-
15	-	-
16	SOL1_OPEN	solenoid not connected - channel 1
17	SOL2_OPEN	solenoid not connected - channel 2
18	SHORT_CH_1	short circuit - channel 1
19	SHORT_CH_2	short circuit - channel 2
20	I2T_1	I2T error sol. 1
21	I2T_2	I2T error sol. 2
22	EF_AN_MONITOR	Analog monitor fault
23	OVERTEMPUP	uP OverTemperature Error
24	OVERTEMPHBRIDGE	HBridge OverTemperature Error
25	EEPROM_ERROR	EEProm error
26	UNDERVOLT_CTRL	Undervoltage of the power stage - Hbridges
27	OVERVOLT_CTRL	Overvoltage of the power stage - Hbridges
28	-	-
29	-	-
30	-	-
31	-	-

Consuming Assembly

Input Assembly according to table below (Assembly Number 101) size in byte 8

Byte	Function	Type	Bit Length	
0..1	Control Word		16	
2-3	Reference		16	-10000, +10000 expressed in 0.01%
4-7	Reserved		32	

Description of the **Control Word**

Bit Number	Name	Description	Type	Default
0	Disabled	Device Condition	Bool	0
1	Hold enable	Device Condition	Bool	0
2	Device Mode Active Enable	Device Condition	Bool	0
3	Reset fault	It is possible to reset faults, if not active	Bool	0
4	Reserved		Bool	0
5	Reserved		Bool	0
6	Reserved		Bool	0
7	Reserved		Bool	0
8	Reserved		Bool	0
9	Reserved		Bool	0
10	Reserved		Bool	0
11	Reserved		Bool	0
12	Reserved		Bool	0
13	Reserved		Bool	0
14	Reserved		Bool	0
15	Reserved		Bool	0

Example: in order to reach the Device Mode Active condition, it is possible to send cyclically the control word x111. Three cycles after the device init successful, the valve will reach the DEVICE_MODE_ACTIVE, if there are no faults.

Led Description

Boards with Ethernet IP interface are equipped with five leds, the meaning of these leds according to table below:

Number	Name	Function	Colour	Status	Meaning
L1	SYS	System Status	Green	On	Operating System Running
			Green/Yellow	Blinking Green/Yellow	Bootloader is waiting for Firmware
			Yellow	Static	Bootloader is waiting for Software
			-	Off	Power Supply for the device is missing or hardware defect
L2	MS	Module Status	Green	On	OK
			Red	Off	Error
L3	NS	Network Status	Green	On	Connected: If the device has at least one established connection (even to the Message Router), the network status indicator shall be steady green.
				Flashing	Not Connections: If the device has no established connections, but has obtained an IP address, the network status indicator shall be flashing green.
			Red	On	Duplicate IP: If the device has detected that its IP address is already in use, the network status indicator shall be steady red.
				Flashing	Connection Timeout: If one or more of the connections in which this device is the target has timed out, the network status indicator shall be flashing red. This shall be left only if all timed out connections are reestablished or if the device is reset.
			Green/Red	Blinking Green/Red	Self-Test: While the device is performing its power up testing, the network status indicator shall be flashing green/red
			-	Off	Not powered, no IP Address: If the device does not have an IP address (or is powered off), the network status indicator shall be steady off.
L4	Eth CH0	LINK	Green	On	A connection to the Ethernet exists
				Off	The device has not connection to the Ethernet
		ACT	Yellow	Flashing	The device sends/receives Ethernet frames
L5	Eth CH1	LINK	Green	On	A connection to the Ethernet exists
				Off	The device has not connection to the Ethernet
		ACT	Yellow	Flashing	The device sends/receives Ethernet frames