

1500K Series

Roller Bearing Gear Pumps and Motors (Bi-Rotational)

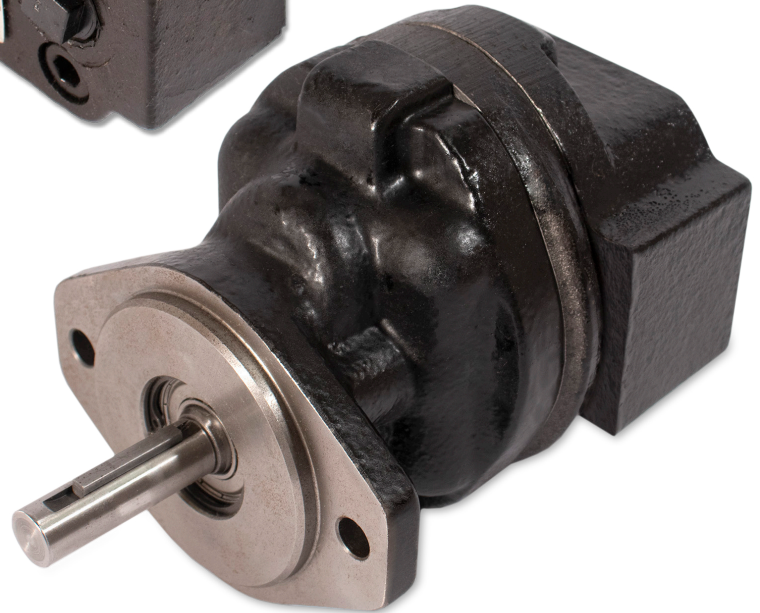

1500K



► DESCRIPTION:

The 1500K Series Pump/Motor utilizes the many design and application features of the widely accepted HYDRECO gear pump and motor technology. The pump contains pressure-balanced wear plates. The series maintains its bi-rotational pump or motor capabilities made possible by use of check valves which drain back to the low pressure side.

► PERFORMANCE:

Max operating pressure:	PSI [bar]	2500 (172)
Maximum flow rate in the controlled line P		21 [80]
Maximum flow rate in the free lines	GPM [l/min]	26 [100]
Drain flow rate		≤ 0.21 [≤ 0.8]
Ambient temperature range	°F [°C]	-4 to 140 [-20 to +60]
Fluid temperature range	°F [°C]	-4 to 176 [-20 to +80]
Fluid viscosity range	cSt	10 - 400
Recommended viscosity	cSt	25
Fluid contamination degree		according to ISO 4406:1999 class 20/18/15
Mass: 1500K Standard	lbs [kg]	6.0 [2.7]

1500K RPM RATINGS				
Model	Max. Continuous psi (bar)	Max. rpm as pump	Max. rpm as motor	Mass:
1506K	2500 (172.5)	4000	-	21 lbs
1510K	2500 (172.5)	4000	-	22 lbs
1512K	2500 (172.5)	3600	4000	23 lbs
1515K	2500 (172.5)	3200	3600	24 lbs
1518K	2000 (138)	2600	3200	25 lbs

► FLUIDS:

FIRE RESISTANT FLUIDS

Non-Mineral Based Fluids change the rating of units due to specific gravity and lubricity of the fluid.

FLUIDS					
Type	Maximum RPM	Maximum Pressure	Maximum Temperature	Minimum Inlet Pressure	Bearing life in comparison to petroleum based fluid
Synthetic	2000	2000 psi (137.9 bar)	180° F (82.2° C)	5 inches of Hg.	100%
Water Glycol	1800	1000 psi (68.9 bar)	130° F (54.4° C)	3 inches of Hg.	100%
Invert Emulsion	1800	1000 psi (68.9 bar)	130° F (54.4° C)	3 inches of Hg.	100%

► **FEATURES:**

1500K Bi-Rotational Gear Pump/Motor

- The 1500K Series Pump/Motor utilizes the many design and application features of the widely accepted HYDRECO Series modern high pressure, high speed, gear pump and motor technology.
- Operating as pumps, the smaller units can be applied at speeds up to 4000 rpm and pressures to 2500 psi. Operating as motors, the same pressures can be used, but the speed ratings of the larger units are further increased. In addition to all this added capability, expected life of the heavy duty version exceeds the long life experienced from the 1500 series.
- The series maintains its bi-rotational pump or motor capabilities made possible by the use of check valves which drain back to the low pressure side. This allow the units to be applied as either a pump or motor with full system pressure on both the inlet and outlet if required. When used as such, a small external drain line will be required if inlet pressure exceeds 150 psi.
- The 1500K configuration uses heavy duty iron castings for the higher working pressures and it maintains the unique four-bolt design which places all four assembly bolts within the area of greatest internal pressure. This design maintains perfect alignment and thus eliminates any decrease in efficiency at high pressures. This greatly reduces internal distortion and the resulting wear of internal parts
- An important feature of the 1500K pump/motor is the deflecting pressure-balanced wear plates. By balancing pressure forces on the front and back of the wear plates a precise balance is obtained between minimum clearances for high volumetric efficiencies and minimum contact of rotating and fixed parts for low mechanical losses.
- A new plus is the relief cover and the flow control cover available on the 1500K. You may also have the relief and flow control combined in the same cover. The flow is rated from 2 to 13 gpm. This will make the 1500K pump/motor much more versatile by providing oil for two circuits with one pump.
- The roller bearing design which uses fully pressure lubricated, long life roller bearings makes these units relatively insensitive to contamination. This feature also makes the unit fully repairable .
- The use of an outboard bearing in some models allows limited side loading of the input/output shaft.
- Displacements: 0.736 cir, (12.10 ccr) - 2.066 cir (33.86)
- Operating as pumps, 4000 RPM and 2500 psi (172.5)
- Operating as motors, 3600 RPM and 2500 psi (172.5)
- The 1500K can be used as a pump or motor by adding a case drain as a motor.

CROSS SECTION OF 1500K SERIES PUMP/MOTOR

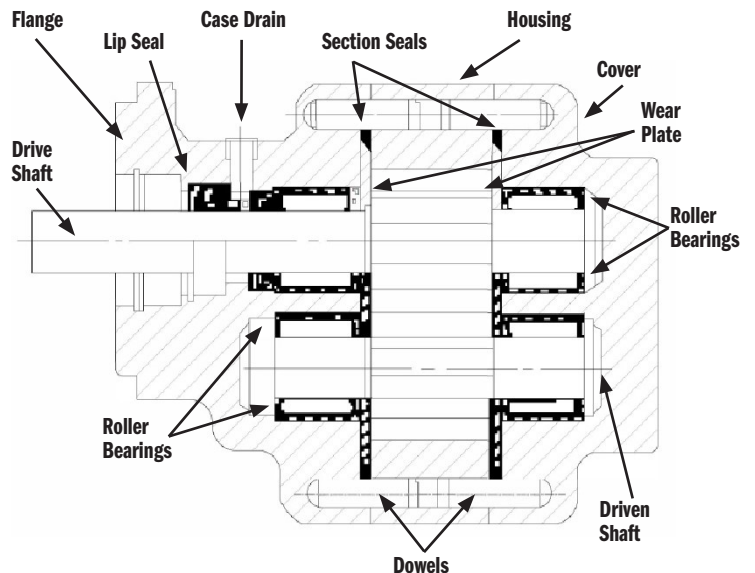

► **IDENTIFICATION CODE:**

1506K

NOTE: Additional adapters, shaft, and port options are available. Consult Factory.

SERIES 1500K	
CODE	GPM / 2000 PRM CIR (CCR)
06	0.738 (12.10 ccr)*
10	1.180 (19.34 ccr)*
12	1.476 (24.19 ccr)
15	1.771 (29.02 ccr)
18	2.066 (33.86 ccr)

DESIGN	
CODE	DESCRIPTION
A	(Standard) No outboard bearing
C	With shielded outboard bearing
E	Telltale drain

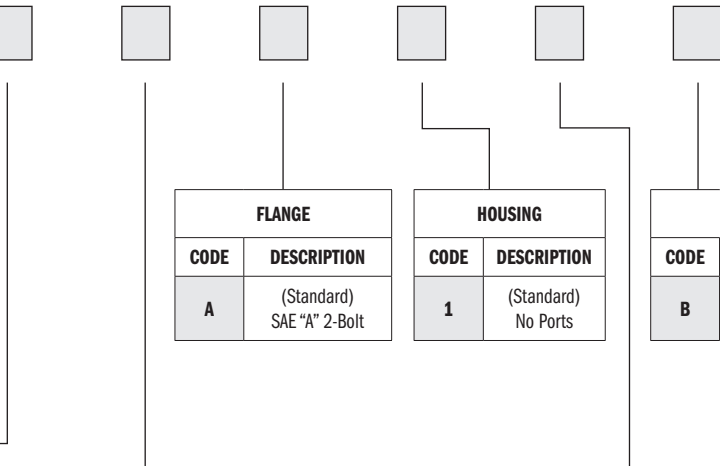

FLANGE	
CODE	DESCRIPTION
A	(Standard) SAE "A" 2-Bolt

HOUSING	
CODE	DESCRIPTION
1	(Standard) No Ports

ROTATIONS	
CODE	DESCRIPTION
B	(Standard) Bi-rotational

SHAFT				
CODE	NAME	DIA.	DESCRIPTION	ADAPTERS
1	(Standard) SAE "A" Spline	5/8"	1.16" Long Full spline 9 teeth	A Only
2	SAE "A" Parallel ST. Shaft W/Key	5/8"	1" Long 3/16" Sq. Key 7/8" Long	A Only
3	Parallel Shaft ST. Shaft W/Key	5/8"	2.125" Long 3/16" Sq. Key 1-1/4" Long	A Only

COVERS	
CODE	DESCRIPTION
A	3/4" - 14 NPT Pipe Thread Ports (4) Side & Rear - Side Ports have pipe plugs
F	(Standard) 1-1/16"- 12 UN 2B Straight Thread Side Ports only

*Notes if used as a motor. see page 6. Other shaft are available on request

SHAFT

Additional shaft and port options are available. Please contact engineering for more details.

- (1) SAE volumetric rating is per SAE J745C.
- (2) Mounting flanges noted as SAE conform to SAE J744C.

TYPICAL ORDERING CODE:
1506KA1A1AB

1500K MAXIMUM RECOMMENDED DRIVE SHAFT TORQUE TRANSMISSION CAPACITY

Satisfactory drive shaft torque transmission capacity is indicated with the product of pressure (P) and is displacement (D) is less than or equal to (<=) a given constant. The unit of "P" and "D" are expressed in psig and in³/rev. (cir) respectively.

► **SHAFT OPTIONS:**

Dimensions:
inches (± .125")
millimeters (± 1 mm)

NO. 1

SAE "A" SPLINE

INVOLUTE
Flat root-side of tooth fit
Dia. Pitch - 16/32
Pres. Angle 30°
No. of teeth - 9
Major Dia. - .6245-.618
(15.862-15.697)

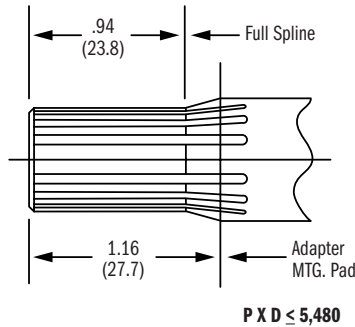

SHAFT				
CODE	NAME	DIA.	DESCRIPTION	ADAPTERS
1	(Standard) SAE "A" Spline	5/8"	1.16" Long Full spline 9 teeth	A Only
2	SAE "A" Parallel ST. Shaft W/Key	5/8"	1" Long 3/16" Sq. Key 7/8" Long	A Only
3	Parallel Shaft ST. Shaft W/Key	5/8"	2.125" Long 3/16" Sq. Key 1-1/4" Long	A Only

ADDITIONAL SHAFT OPTIONS ARE AVAILABLE

Contact Sales for more details.

NO. 2

SAE "A" Parallel ST. Shaft W/Key

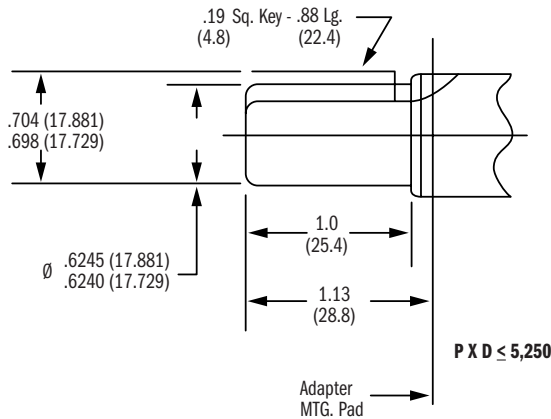

1500K MAXIMUM RECOMMENDED DRIVE SHAFT TORQUE TRANSMISSION CAPACITY

Satisfactory drive shaft torque transmission capacity is indicated with the product of pressure (P) and is displacement (D) is less than or equal to (<) a given constant. The unit of "P" and "D" are expressed in psig and in³/rev. (cir) respectively.

NO. 3

Parallel Shaft ST. Shaft W/Key

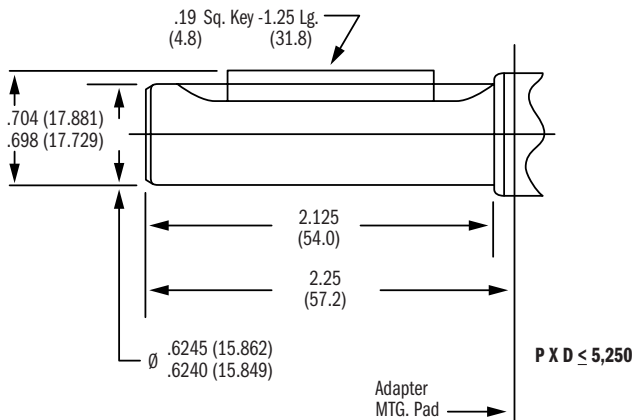

► PERFORMANCE DATA:

Performance Data on Hydraulic Gear Pump

• Shown are the average results based on a series of laboratory tests of production units and are not necessarily representative of any one unit. Tests were run with the oil reservoir temperature at 120° F and viscosity 150 SSU at 100° F.

Requests for more specific data should be directed to our Technical Service Department through our Sales Representatives.

- Consult your Hydreco Sales Representative for operation of pumps at (1) pressures and speeds above those shown on charts, (2) temperatures above 180° F, (3) speeds under 600 rpm when under load.
- Ten micron Wear Protective filtration is recommended for maximum pump life. Beta of 80%
- Feed Characteristics: Max. 5" Hg. vacuum at rated speed.

1500K Maximum Allowable Side Loads

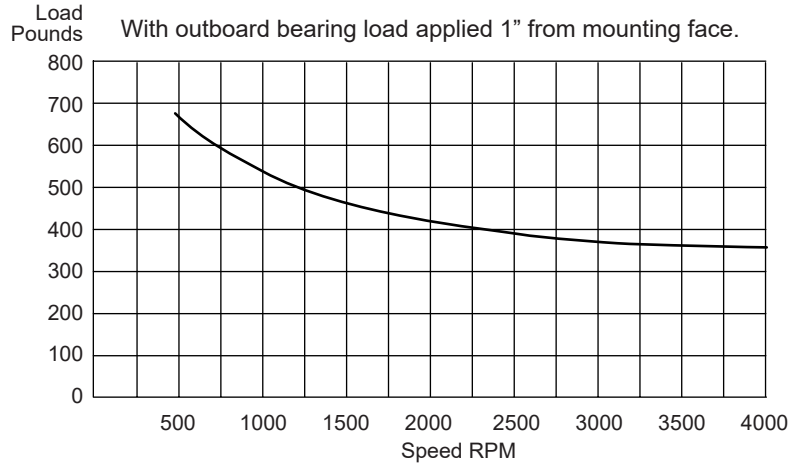

For 1500K Dual Pump, Combine the Chart Output

1506K Pump

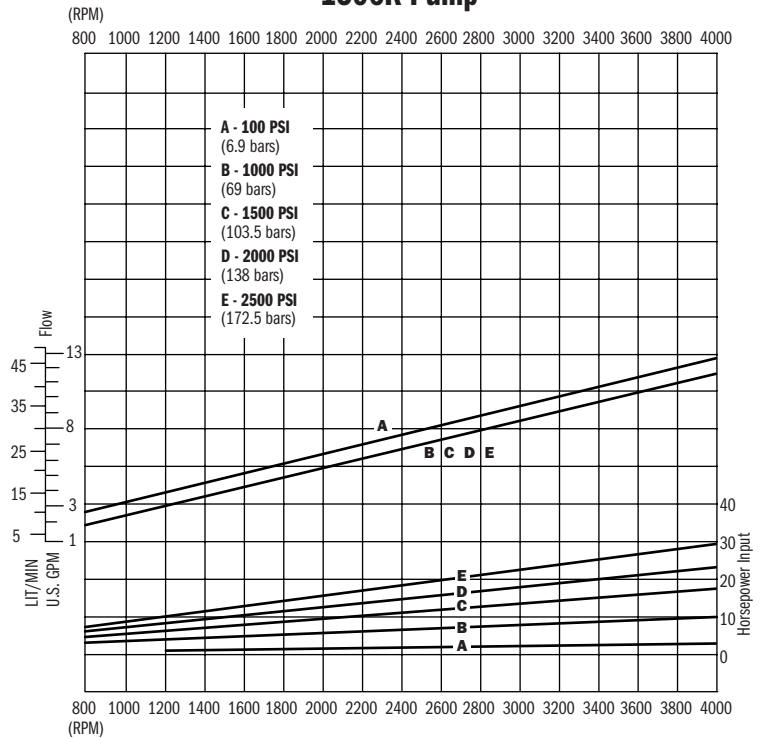

► **PERFORMANCE DATA:**

For 1500K Dual Pump, Combine the Chart Output

1510K Pump

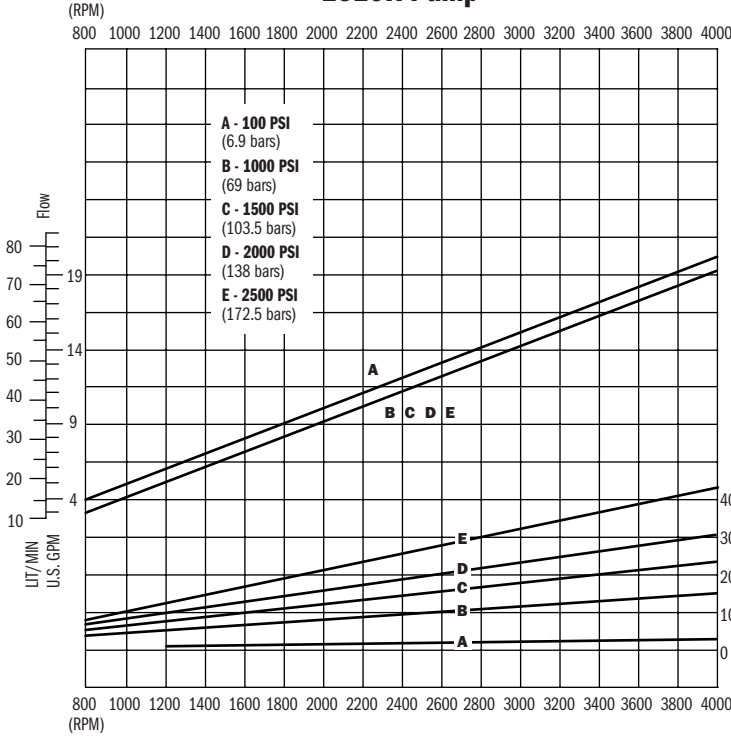

1512K Pump

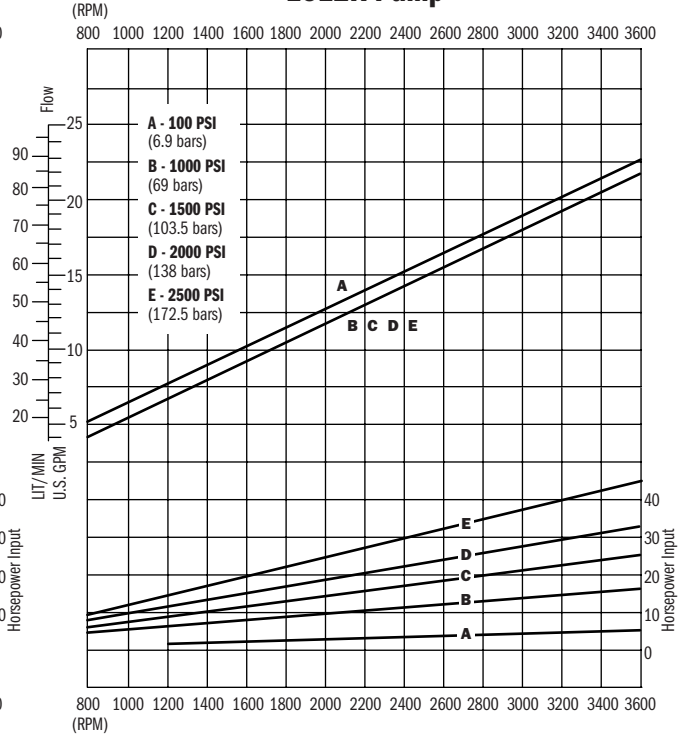

For 1500K Dual Pump, Combine the Chart Output

1515K Pump

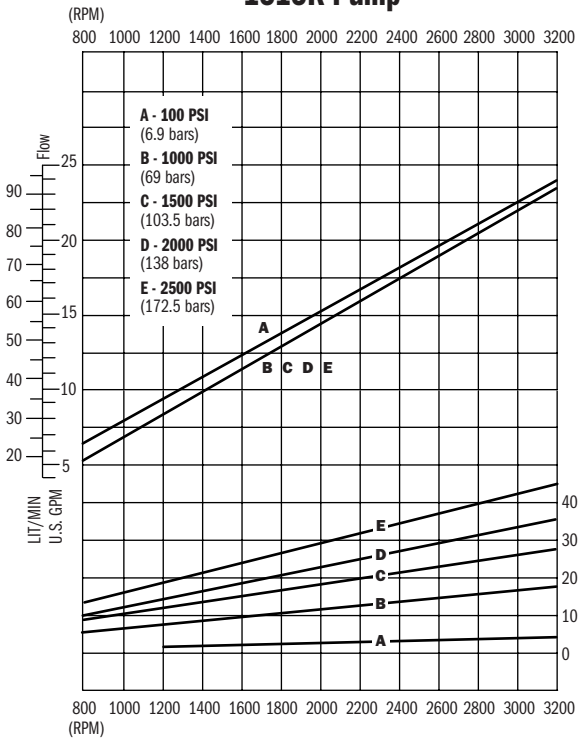

1518K Pump

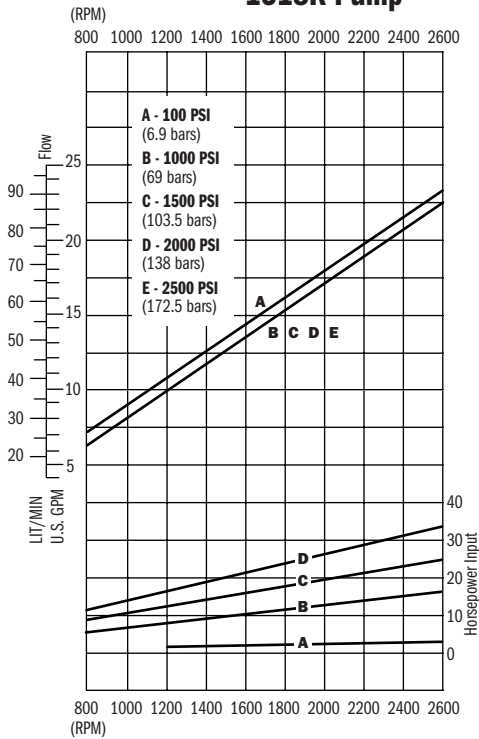

► **PERFORMANCE DATA:**

For 1500K Dual Motor, Combine the Chart Output

Performance Data on Hydraulic Gear Motor

- Shown are the average results based on a series of laboratory tests of production units and are not necessarily representative of any one unit. Tests were run with the oil reservoir temperature at 120° F and viscosity 150 SSU at 100° F. Requests for more specific data should be directed to our Technical Service Department through our Sales Representatives.
- Consult your Hydreco Sales Representative for operation of pumps at (1) pressures and speeds above those shown on charts, (2) temperatures above 180° F, (3) speeds under 600 rpm when under load.
- Ten micron Wear Protective filtration is recommended for maximum motor life.
- Positive input pressure recommended at all speeds. NOTE: If low pressure side is above 150 psi use external drain.

NOTE: 1506K and 1510K not recommended for use as motors. Consult Hydreco.

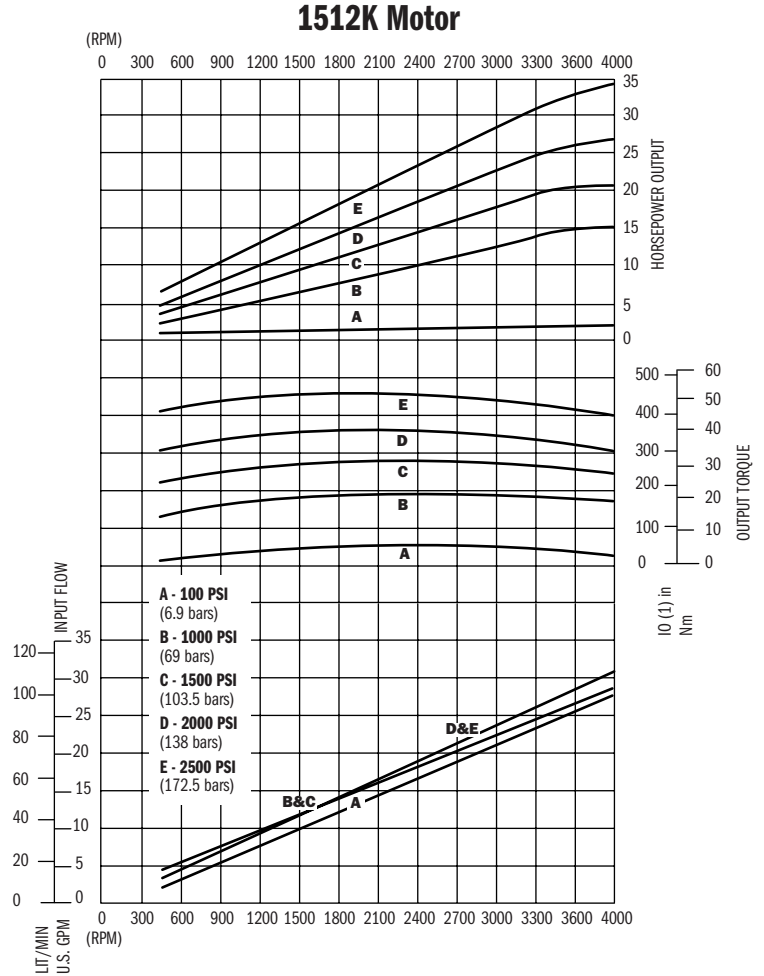

► **PERFORMANCE DATA:**

1515K Motor

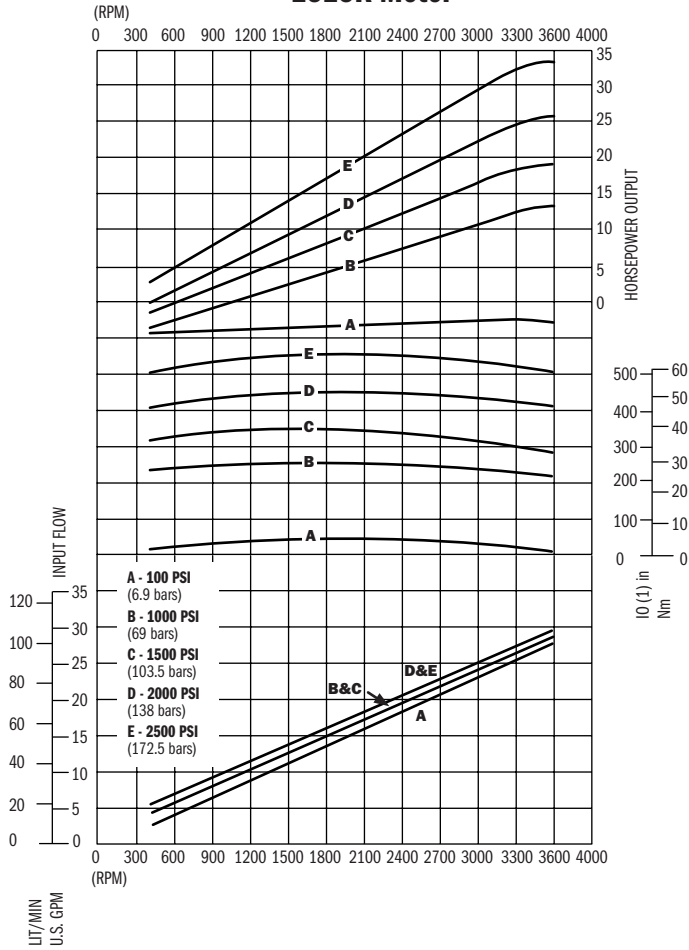

1518K Motor

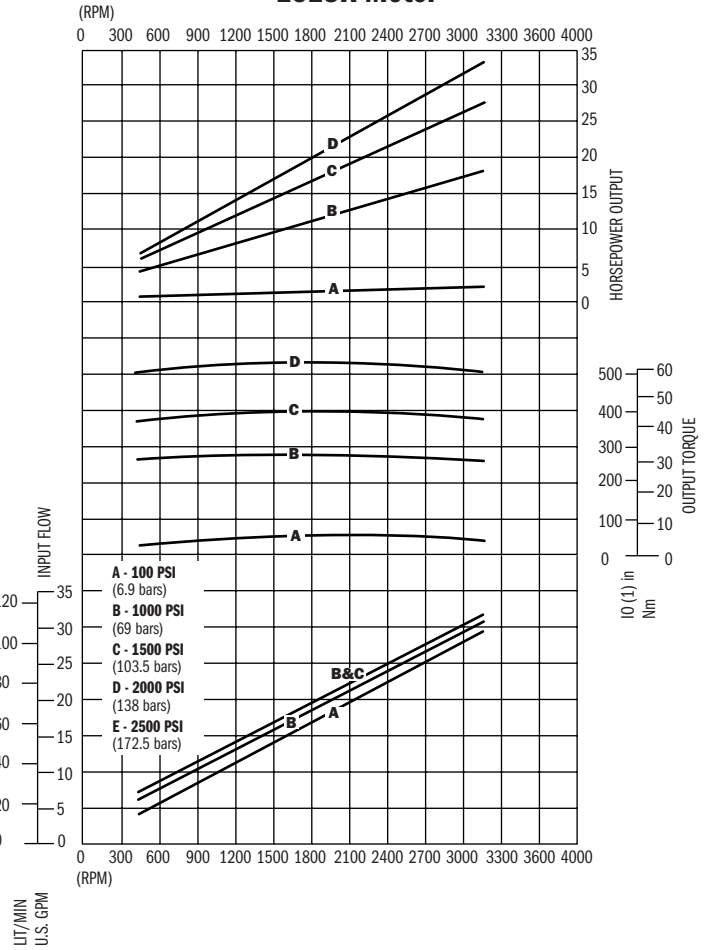

► **INSTALLATION DATA: Flange "A"**

Dimensions:
inches (± .125")
millimeters (± 1 mm)

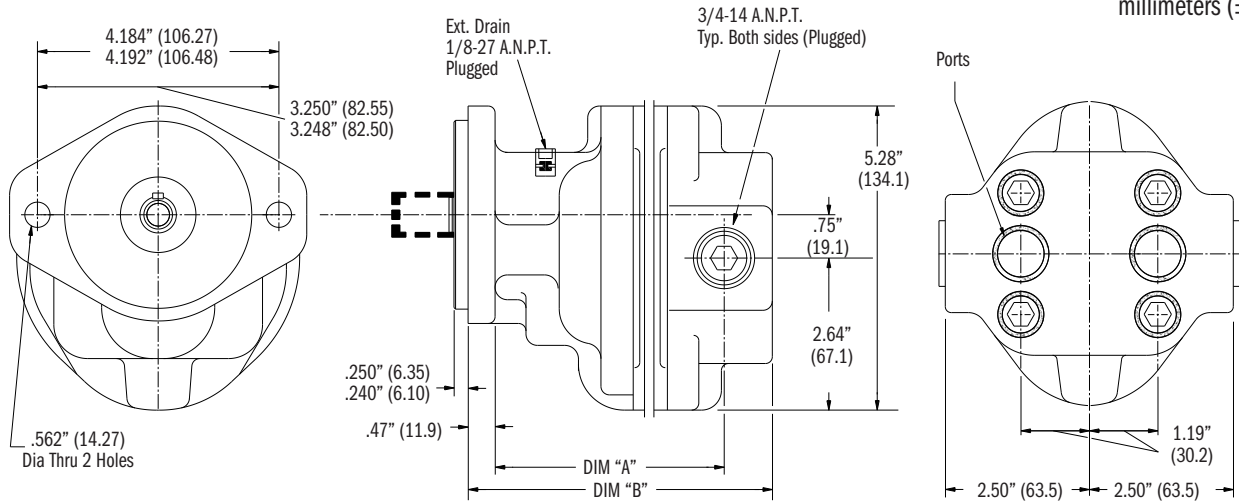

Model No. with A Covers	Dim. "B" with Flange A	Dim. "A" with Flange A	Max. Opr PSI & (bars)	Max. RPM
1506 - .738 cir	5.44" (138.2)	4.38" (111.3)	2500 (172.5)	4000
1510 - 1.180 cir	5.81" (147.6)	4.75" (120.7)	2500 (172.5)	4000
1512 - 1.476 cir	6.06" (153.9)	5.00" (127.0)	2500 (172.5)	3600
1515 - 1.771 cir	6.31" (160.3)	5.25" (133.4)	2500 (172.5)	3200
1518 - 2.066 cir	6.56" (166.6)	5.50" (139.7)	2000 (138.0)	2600



CONTINENTAL HYDRAULICS INC. / HYDRECO INC.

4895 12th Avenue East, Shakopee, Minnesota 55379

952.895.6400 • sales@conthyd.com • www.continentalhydraulics.com

704.295.7575 • sales-us@hydreco.com • www.hydreco.com

© 2023 CONTINENTAL HYDRAULICS Inc., All Rights Reserved. Product specifications and appearance are subject to change without notice.